



USER MANUAL

FOR TECHMAN ROBOTS

v1.8.0

Original Instructions

Contents

1. Introduction.....	5
1.1. Important Safety Notice.....	5
1.2. Scope of the Manual.....	5
1.2.1. Sander.....	5
1.2.2. Software and Firmware.....	5
1.2.2.1. Compute Box.....	5
1.3. Naming Convention.....	5
1.3.1. Compute Box/Eye Box.....	5
1.3.2. Sander.....	5
1.4. Copyright.....	6
2. Safety.....	7
2.1. Intended Use.....	7
2.2. General Safety Instructions.....	7
2.3. Risk Assessment.....	8
2.4. Environmental Safety.....	9
2.5. Sander.....	9
3. HW Installation.....	10
3.1. Overview.....	10
3.2. Robot Mount.....	10
3.2.1. Quick Changer Mounting.....	10
3.2.1.1. Quick Changer - Robot Side.....	10
3.2.1.2. Sander.....	10
3.2.2. Tools.....	10
3.2.2.1. Sander.....	10
3.3. Compute Box Mount.....	11
3.3.1. Optional - Clip-on Bracket.....	11
3.4. Wiring.....	12
3.4.1. Tool Data Cable.....	12
3.4.1.1. Cable to Sander.....	12
3.4.1.2. Cable to Compute Box.....	12
3.4.2. Ethernet Cable.....	13
3.4.3. Compute Box DIP Switch Settings.....	14
3.4.4. Power Supply: Sander.....	14
3.4.5. Power Supply: Compute Box.....	14
3.4.5.1. Sander.....	15
4. SW Installation.....	16
4.1. Robot Software Setup.....	16
4.1.1. Import Component.....	16
4.1.2. Set Robot Network Settings.....	18

4.1.3. Configure Gripper Buttons.....	19
4.1.4. Configuring Modbus TCP for the Components.....	20
5. Operation.....	23
5.1. Robot Operation Overview.....	23
5.2. Sander Components.....	25
5.2.1. SDR_GetParameters.....	25
5.2.2. SDR_SetRPM.....	26
5.3. Sander Application Guideline.....	26
6. Additional Software Options.....	28
6.1. Compute Box/Eye Box.....	28
6.1.1. Ethernet Interface Setup.....	28
6.1.2. Web Client.....	30
6.1.3. Web Client: Devices Menu.....	31
6.1.3.1. Sander.....	32
6.1.4. Web Client: Configuration Menu.....	33
6.1.5. Web Client: Update Menu.....	34
6.1.6. Web Client: Account Settings.....	36
7. Hardware Specification.....	40
7.1. Technical Sheets.....	40
7.1.1. Sander.....	40
7.1.2. Compute Box.....	41
7.1.2.1. With 1.5A Wall Adapter (36W).....	41
7.1.2.2. With 6.25A Wall Adapter (150W).....	41
7.1.2.3. Compute Box I/O interface.....	41
7.2. Mechanical Drawings.....	43
7.2.1. Mountings.....	43
7.2.1.1. Quick Changer - Robot Side.....	43
7.2.2. Tools.....	44
7.2.2.1. Sander.....	44
7.2.2.2. Power Supply of the Sander.....	44
7.2.2.3. Compute Box.....	45
7.3. COG, TCP.....	45
7.3.1. Sander.....	46
8. Maintenance.....	47
9. Troubleshooting.....	48
9.1. Robot Has Not Obtained an IP Address.....	48
9.2. Error During Operation.....	48
10. Warranties.....	49
10.1. Patents.....	49

10.2. Product Warranty.....	49
10.3. Disclaimer.....	49
11. Certifications.....	50
11.1. EMC.....	51
11.2. Declaration of Incorporation.....	52
11.2.1. Sander.....	52

1. Introduction

1.1. Important Safety Notice



DANGER:

You must read, understand, and follow all safety information in this manual, and the robot manual and all associated equipment before initiating robot motion. Failure to comply with safety information could result in death or serious injury.

1.2. Scope of the Manual

The manual covers the following OnRobot products and their components:

1.2.1. Sander

Tool	Version
OnRobot Sander	v1

1.2.2. Software and Firmware

1.2.2.1. Compute Box

The manual covers the following Compute Box software version:

Software	Version
Compute Box	v5.8.1



NOTE:

When the used Compute Box has lower software/firmware version, update the Compute Box. For detailed instructions, see [6.1.5. Web Client: Update Menu](#).

1.3. Naming Convention

1.3.1. Compute Box/Eye Box

Eye Box and Compute Box are used interchangeably.

1.3.2. Sander

In this user manual, the OnRobot Sander is called SDR or Sander only.

1.4. Copyright

The information contained herein is property of OnRobot A/S and shall not be reproduced in whole or in part without prior written approval of OnRobot A/S. The information herein is subject to change without notice and should not be construed as a commitment by OnRobot A/S. This manual is periodically reviewed and revised.

OnRobot A/S assumes no responsibility for any errors or omissions in this document.

Copyright © 2015–2021 by OnRobot A/S.

The OnRobot A/S logo is trademark of OnRobot A/S.

2. Safety

The robot integrators are responsible for ensuring that the applicable safety laws and regulations in the country concerned are observed and that any significant hazards in the complete robot application are eliminated. This includes, but is not limited to:

- Performing a risk assessment for the complete robot system
- Interfacing other machines and additional safety devices if defined by the risk assessment
- Setting up the appropriate safety settings in the robot software
- Ensuring that the user will not modify any safety measures
- Validating that the total robot system is designed and installed correctly
- Specifying instructions for use
- Marking the robot installation with relevant signs and contact information of the integrator
- Collecting all documentation in a technical file; including the risk assessment and this manual

2.1. Intended Use

OnRobot tools are intended to be used on collaborative robots and light industrial robots with different payloads depending on the end-of-arm tooling specifications. OnRobot tools are normally used in pick-and-place, palletizing, machine tending, assembly, quality testing and inspection and surface finishing applications.

The end-of-arm tooling should only operate under conditions noted in [7.1. Technical Sheets](#) section.

Any use or application deviating from intended use is deemed to be impermissible misuse. This includes, but is not limited to:

- Use in potentially explosive atmospheres
- Use in medical and life critical applications
- Use before performing a risk assessment
- Use outside the permissible operational conditions and specifications
- Use close to a human's head, face and eye area
- Use as a climbing aid

2.2. General Safety Instructions

Generally, all national regulations, legislations and laws in the country of installation must be observed. Integration and use of the product must be done in compliance with precautions in this manual. Particular attention must be paid to the following warnings:

**DANGER:**

You must read, understand, and follow all safety information in this manual, and the robot manual and all associated equipment before initiating robot motion. Failure to comply with safety information could result in death or serious injury.

The information in this manual does not cover designing, installing, and operating a complete robot application, nor does it cover other peripheral equipment that can influence the safety of the complete system. The complete system must be designed and installed in accordance with the safety requirements set forth in the standards and regulations of the country where the robot is installed.

Any safety information provided in this manual must not be construed as a warranty, by OnRobot A/S, that the robot application will not cause injury or damage, even if robot application complies with all safety instructions.

OnRobot A/S disclaims any and all liability if any of OnRobot tools tooling are damaged, changed or modified in any way. OnRobot A/S cannot be held responsible for any damages caused to any of OnRobot tools tooling, the robot, or any other equipment due to programming errors or malfunctioning of any of OnRobot tools.

**WARNING:**

OnRobot tools are not allowed to be exposed to condensing conditions when power is on or when connected to a robot. If condensing conditions appear during transport or storage, the product must be placed between 20 and 40 Celsius degrees for 24 hours before power is applied or before connected to a robot.

It is recommended that OnRobot tools are integrated in compliance with the following guides and standards:

- ISO 10218-2
- ISO 12100
- ISO/TR 20218-1
- ISO/TS 15066

2.3. Risk Assessment

The robot integrator must perform a risk assessment on the complete robot application. OnRobot tools are only components in a robot application and therefore they can be only safely operated if the integrator has considered the safety aspects of the whole application. OnRobot tools are designed with relatively smooth and round design with a limited amount of sharp edges and pinch points

In collaborative applications, the trajectory of the robot can play a significant safety role. The integrator must consider the angle of contact with a human body, e.g. orientate OnRobot tools and workpieces so that the contact surface in the direction of movement is as large as possible. It is recommended that the tool connectors are pointed in the direction opposite to the movement.

OnRobot A/S have identified the potential hazards listed below as significant hazards that must be considered by the integrator:

- Objects flying from OnRobot tools due to loss of grip
- Objects falling down from OnRobot tools due to loss of grip
- Injuries due to collisions between humans and workpieces, OnRobot tools tooling, robot or other obstacles
- Consequences due to loosen of bolts
- Consequences if OnRobot tools cable gets stuck to something
- Workpiece itself represents a hazard

2.4. Environmental Safety

OnRobot A/S products must be disposed of in accordance with the applicable national laws, regulations and standards.

The product is produced with restricted use of hazardous substances to protect the environment; as defined by the EU RoHS Directive 2011/65/EU. These substances include mercury, cadmium, lead, chromium VI, polybrominated biphenyls and polybrominated diphenyl ethers.

Observe national [registration](#) requirements for importers according to EU WEEE Directive 2012/19/EU.



2.5. Sander



WARNING:

The OnRobot Sander is not ATEX certified, therefore, make sure that the dust extraction is sufficient.

3. HW Installation

3.1. Overview

For a successful installation the following steps will be required:

- Mount the components
- Setup the software

In the following sections, these installation steps will be described.

3.2. Robot Mount

1. Mount the robot-specific adapter (if applicable)
2. Mount any optional accessories
3. Mount the Quick Changer option
4. Mount the tool(s) (if applicable)

3.2.1. Quick Changer Mounting

3.2.1.1. Quick Changer - Robot Side

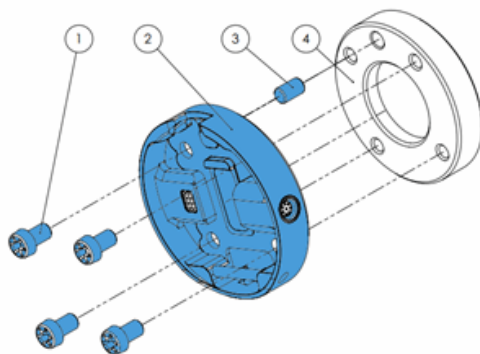

Quick Changer - Robot Side

1. M6x8mm (ISO14580 8.8)
2. Quick Changer (ISO 9409-1-50-4-M6)
3. Dowel pin Ø6x10 (ISO2338 h8)
4. Adapter/ Robot tool flange (ISO 9409-1-50-4-M6)

Use 10 Nm tightening torque.

3.2.1.2. Sander

Tool	QC-R v2	QC-R v2-4.5 A
Sander	✓	✓

3.2.2. Tools

3.2.2.1. Sander

Pad Mounting

Mount the pad to be used on the Sander.



Sander Mounting

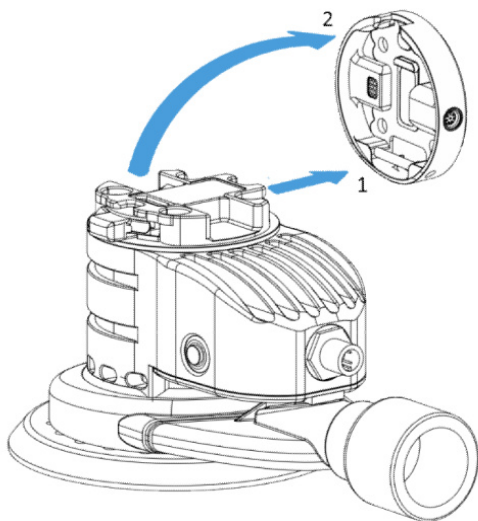

Step 1:

Move the tool close to the Quick Changer as illustrated.

The hook mechanism (rod and hook tongue) will keep the lower part locked once mounted.

Step 2:

Flip the tool until it is fully mated, and you hear a clicking sound.

To unmount the tool, press the aluminum button on the Quick Changer and repeat the steps in the reverse order.

3.3. Compute Box Mount

3.3.1. Optional - Clip-on Bracket

Optionally, fix the Compute Box to a surface using the provided Clip-on Brackets (included only from 17th December 2020).

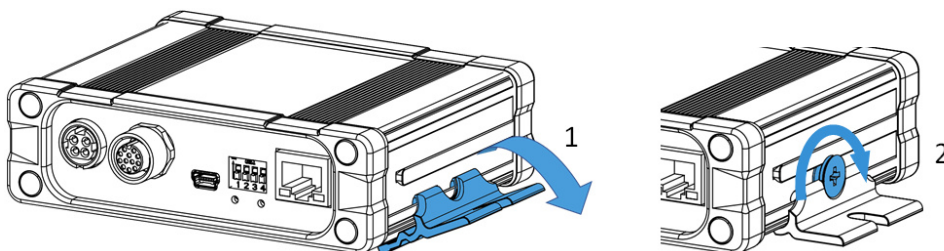

Do the following on both sides of the Compute Box:

1. Hook the Clip-on Bracket to the rail on the side of the Compute Box and then flip it down.
2. Fasten the Clip-on Bracket with the plastic screw.

3.4. Wiring

Three cables need to be connected to wire the system properly:

- Tool data cable between the tool(s) and the Compute Box
- Ethernet communication cable between the robot controller and the Compute Box
- Power supply of the Compute Box

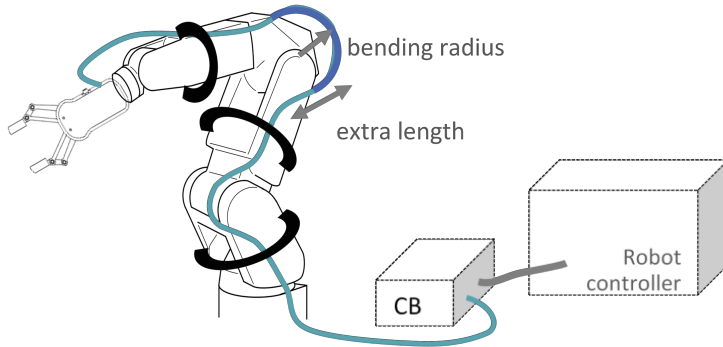

NOTE:

For the Quick Changer - Robot Side no cable is needed to be connected.

3.4.1. Tool Data Cable

3.4.1.1. Cable to Sander

First connect the data cable to the tool.



Use the M8-8pin connector on the Quick Changer or on the Dual Quick Changer.

Use the cable holder as illustrated on the left.



CAUTION:

Make sure to use the supplied cable holder to prevent any excessive strain on the 90-degree M8 connector caused by the rotation of the cable.

3.4.1.2. Cable to Compute Box

Then route the Tool data cable to the Compute Box (CB) and use the supplied Velcro tape (black) to fix it.



NOTE:

Make sure that during the routing some extra length is used at the joints so that cable is not pulled when the robot moves.

Also make sure that the cable bending radius is minimum 40mm (for the HEX-E/H QC it is 70mm).

Finally, connect the other end of the Tool data cable to the Compute Box's DEVICES connector.



CAUTION:

Quick Changer and Dual Quick Changer can only be used to power OnRobot tools.

3.4.2. Ethernet Cable

Connect one end of the supplied Ethernet (UTP) cable to the robot controller's Ethernet (LAN) port.



NOTE:

If the robot controller's Ethernet port is in use, use a standard 4-port Ethernet switch to be able to use two network devices at the same time.

Connect the other end of the supplied cable to the Compute Box's ETHERNET connector.

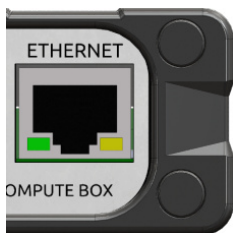

CAUTION:

Use only shielded, maximum 3m long Ethernet cables.



WARNING:

Check and make sure that the Compute Box enclosure (metal) and the robot controller enclosure (metal) are not connected (no galvanic connection between the two).

3.4.3. Compute Box DIP Switch Settings

Set the DIP switches of the Compute Box as follows:

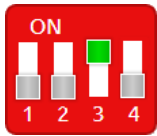

Set the DIP switch 3 to ON and the DIP switch 4 to OFF position.

For more information about the Ethernet interface settings, see [6.1.1. Ethernet Interface Setup](#).

3.4.4. Power Supply: Sander

Connect the Sander and the Sander power supply with the power cable.

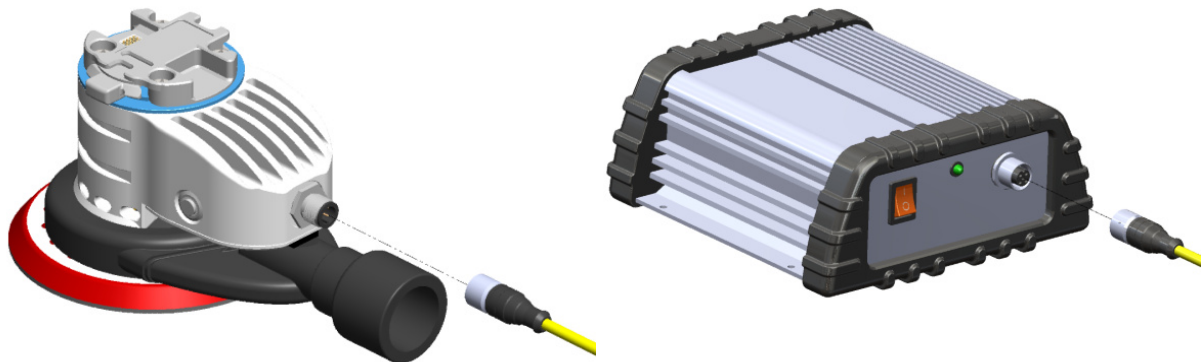

3.4.5. Power Supply: Compute Box

Connect the supplied power supply to the Compute Box 24V connector.

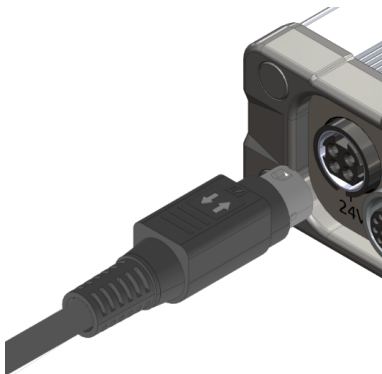
**NOTE:**

To disconnect the power connector, make sure to pull the connector housing (where the arrows are shown) and not the cable.

**CAUTION:**

Use only original OnRobot power supplies.

Finally, power up the power supply that will power the Compute Box and the connected Tool(s).

3.4.5.1. Sander

Power Supply	
1.5 A	✓
5 A	✓
6.25 A	✓

4. SW Installation

4.1. Robot Software Setup

4.1.1. Import Component

OnRobot provides the component in one of the following ways:

1. The component is stored in the accompanying USB stick (OPTIONAL - may not be part of the delivery for some of the devices). Prepare the supplied OnRobot USB stick and plug it into the robot controller.
2. The component can be downloaded from www.onrobot.com. Copy the `TM_Export` folder to the root of an empty USB stick, then rename the USB stick to "TMROBOT". Plug the USB stick into the robot controller.

Click on the main menu  icon and go to  **System** menu.

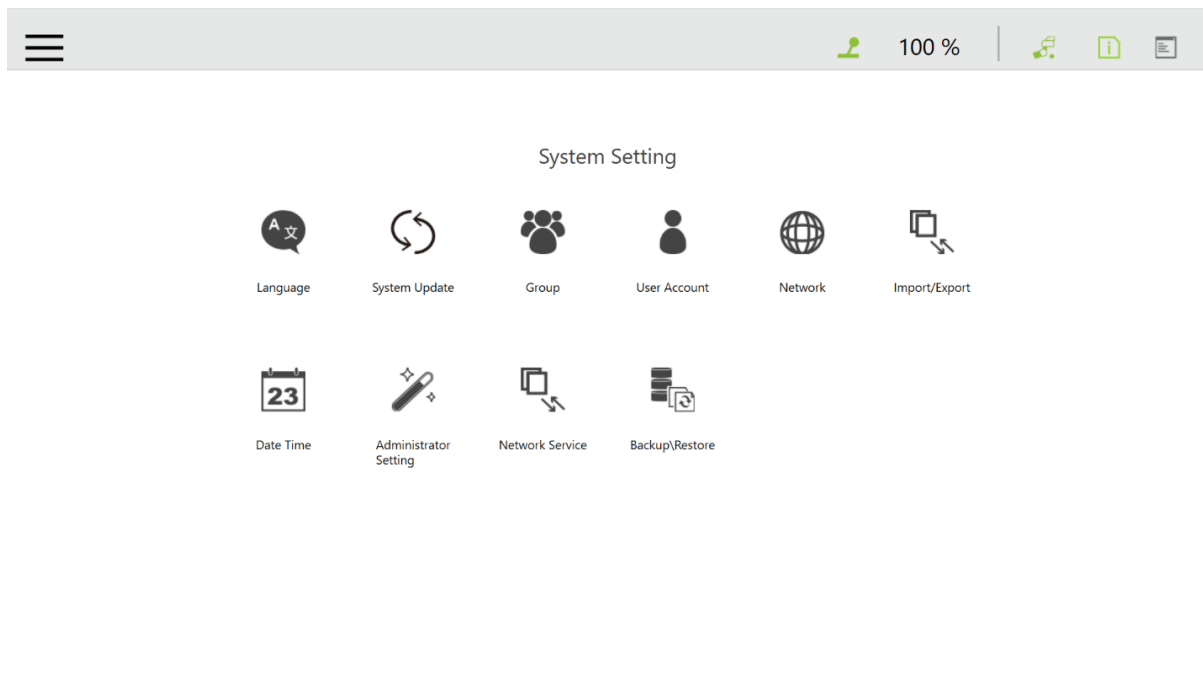

Go to **Import/Export** and click **Import** (upper left corner). Then select your robot from the list and click **OK**.

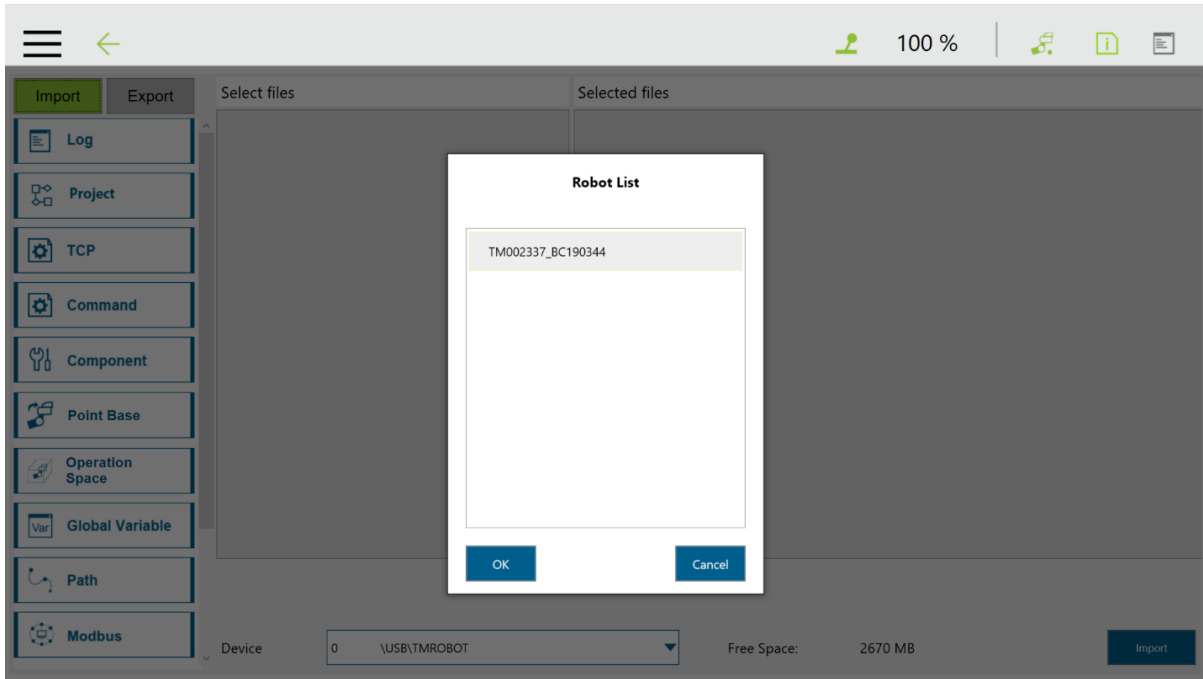

Select the relevant OnRobot components to be added and click **Import**.

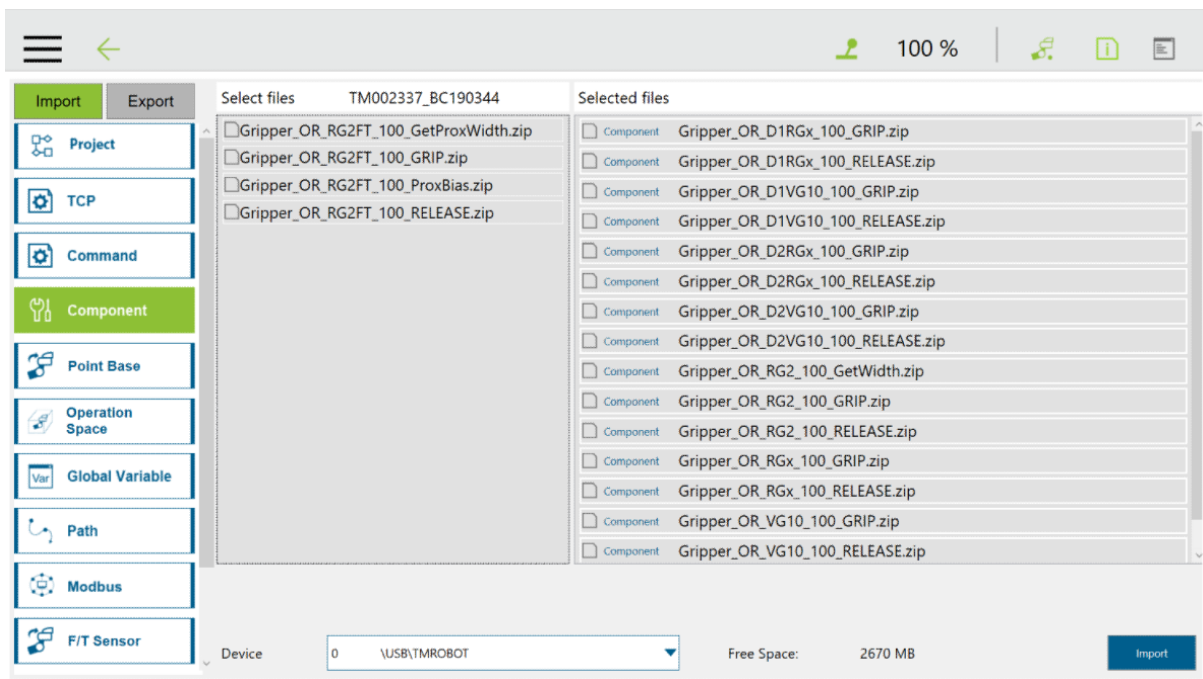

Go back to the main menu (☰) and go to **Settings**.

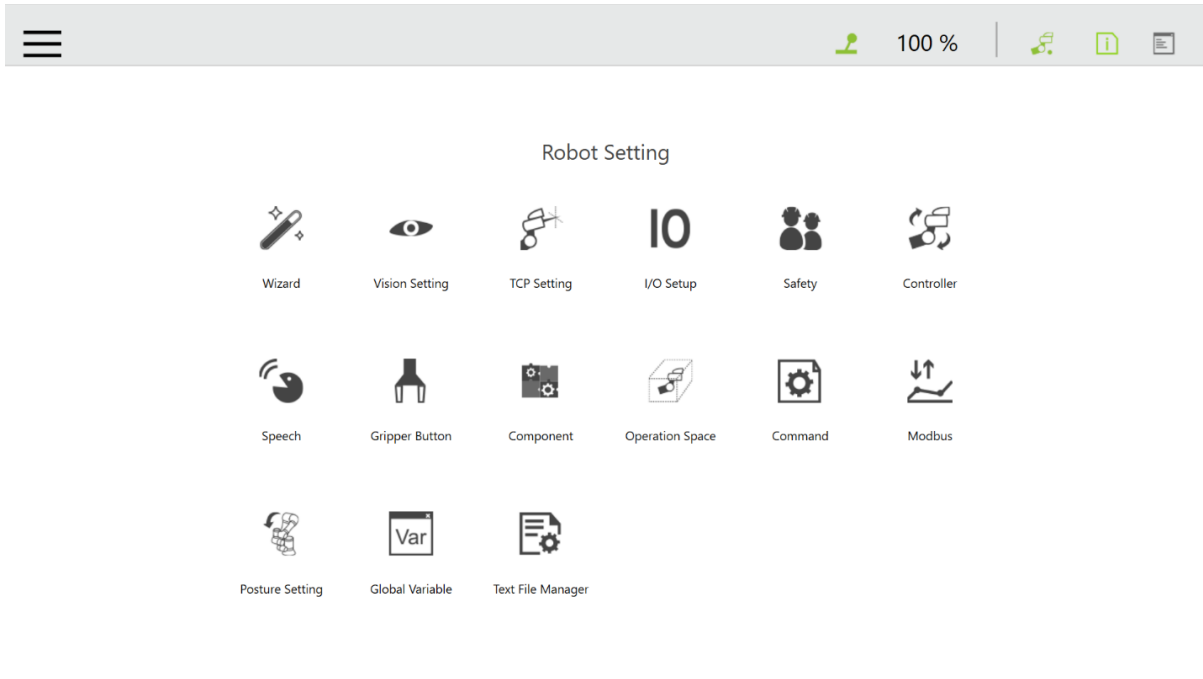

Click **Component** and make sure that all components are enabled that you would like to use.

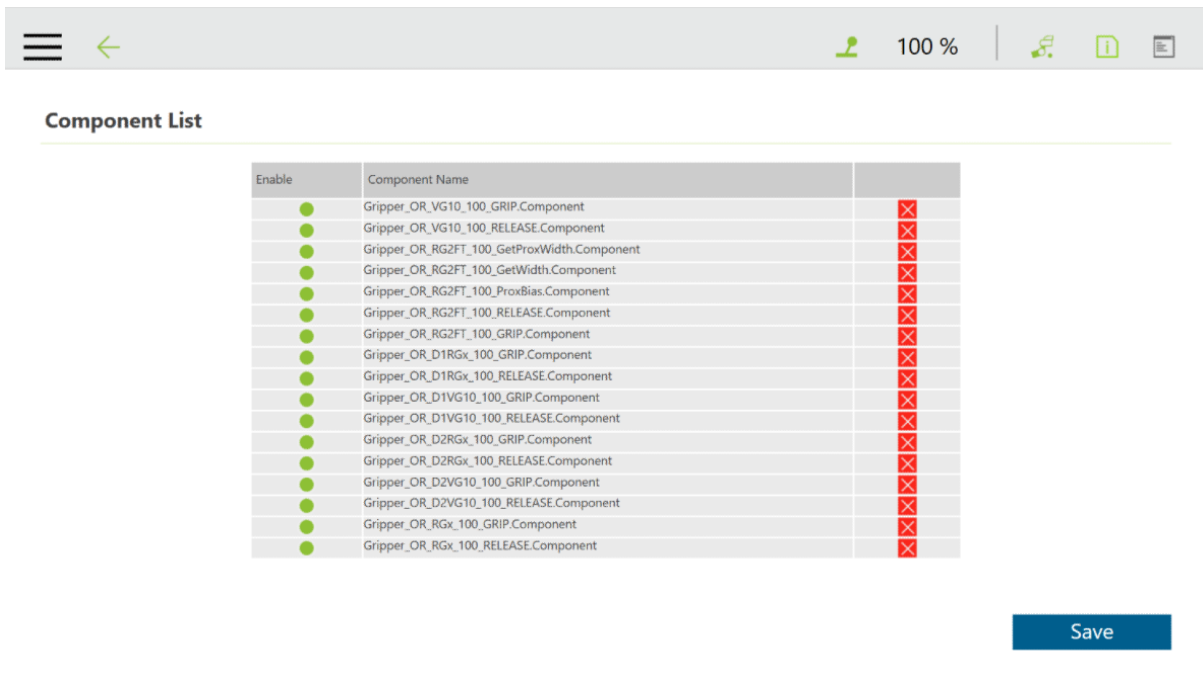

4.1.2. Set Robot Network Settings

Go to the main menu (☰) and go to **Settings**.

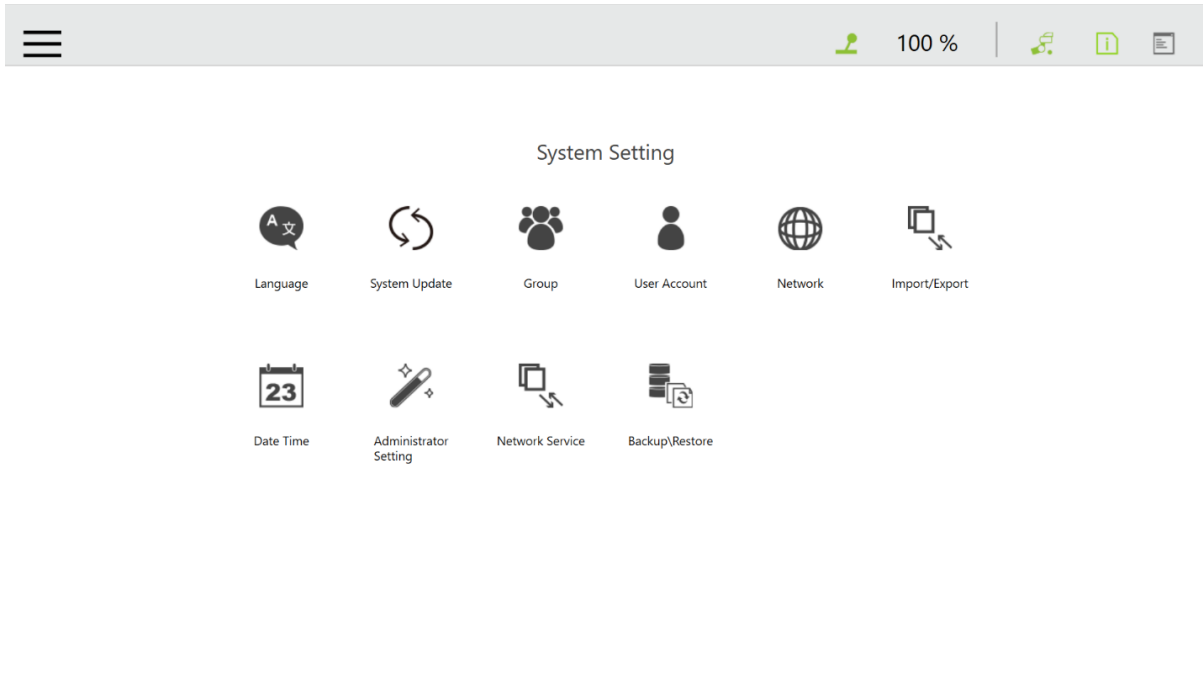

Go to **Network** and setup the IP address of the robot.

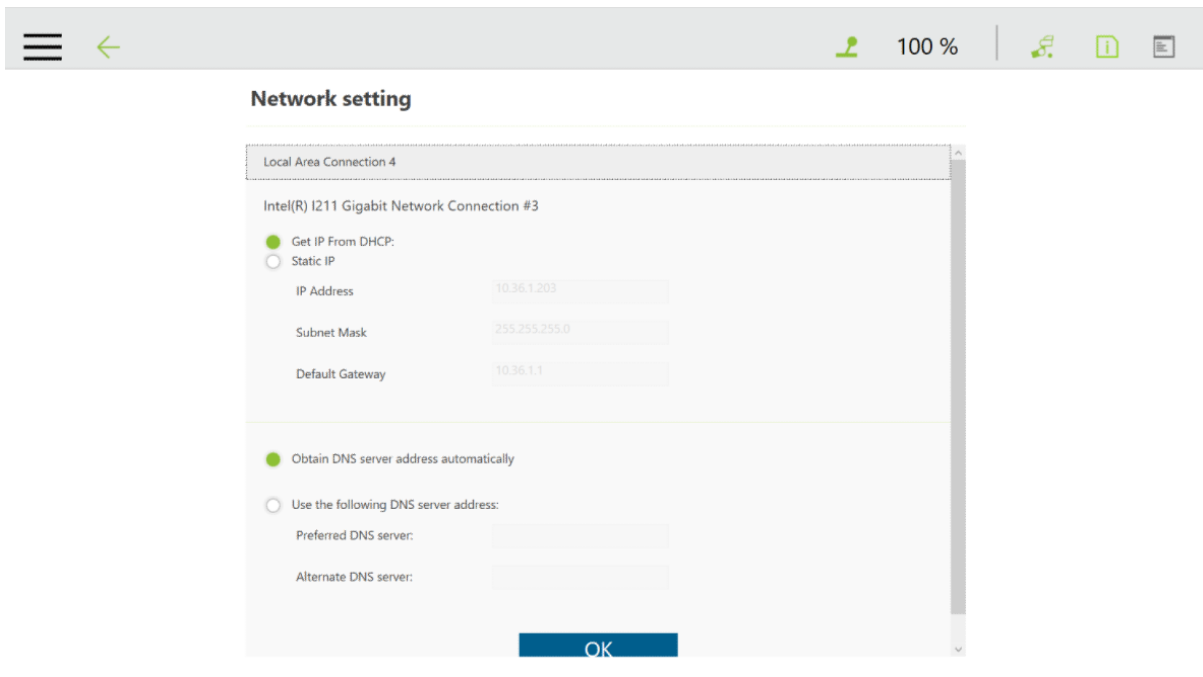

It is recommended to use the factory default settings.

4.1.3. Configure Gripper Buttons

Go to the main menu (☰) and go to **Settings**.

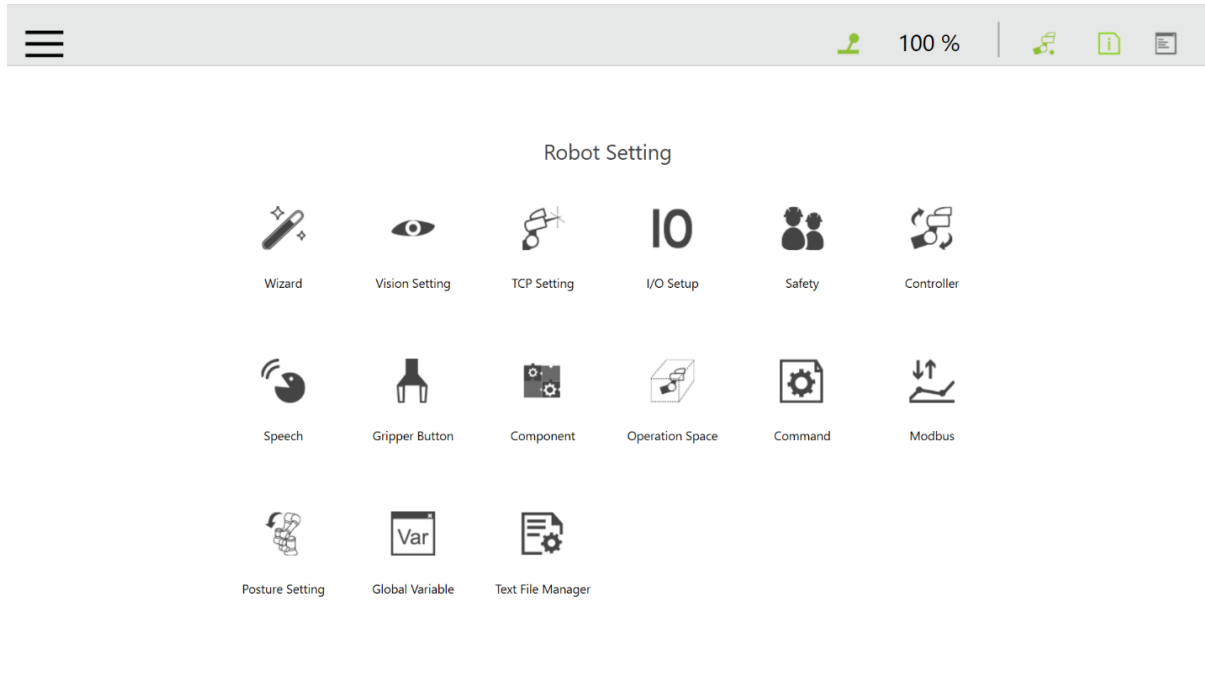

Click on the **Gripper Button** and configure as shown below.

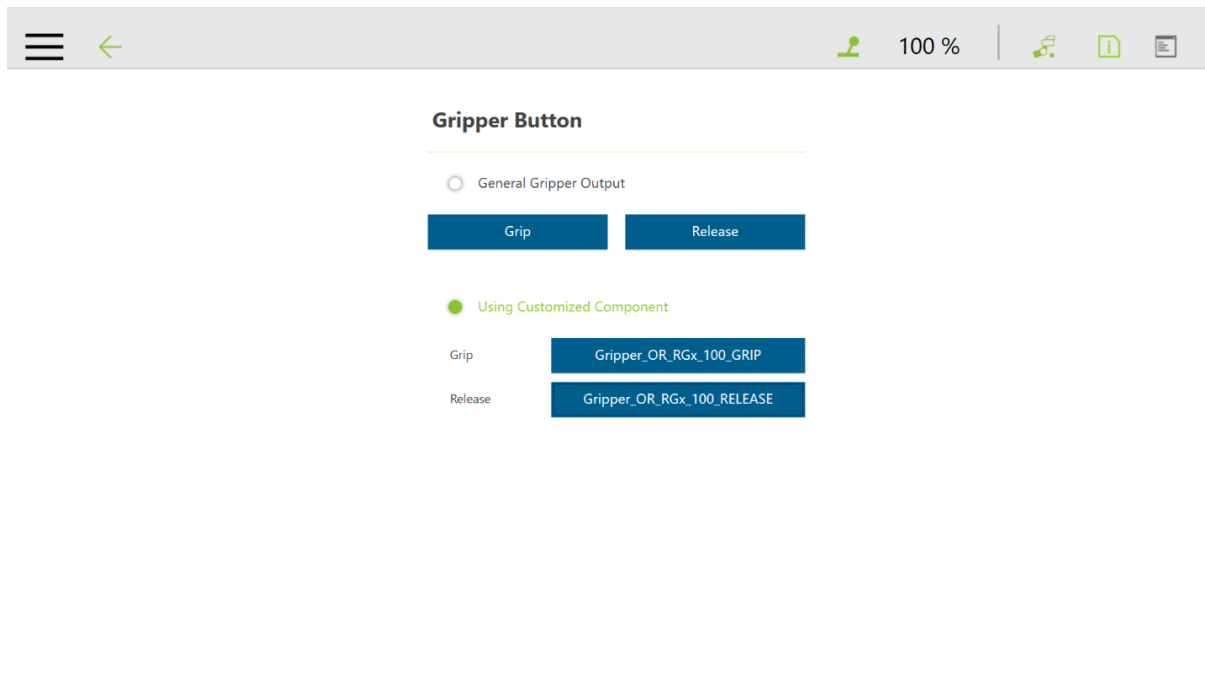

4.1.4. Configuring Modbus TCP for the Components

You can open the `RG2_component_example` project or create a new project.

Add the `RGx_100_GRIP1` component from the left side. Note that not the full component name is shown only the `RGx_100`. You can use the icons to select the right action.

If you are not using the default Compute Box IP (192.168.1.1) then you need to set it. Click on the  icon on the right side of **Display** in the upper right corner.

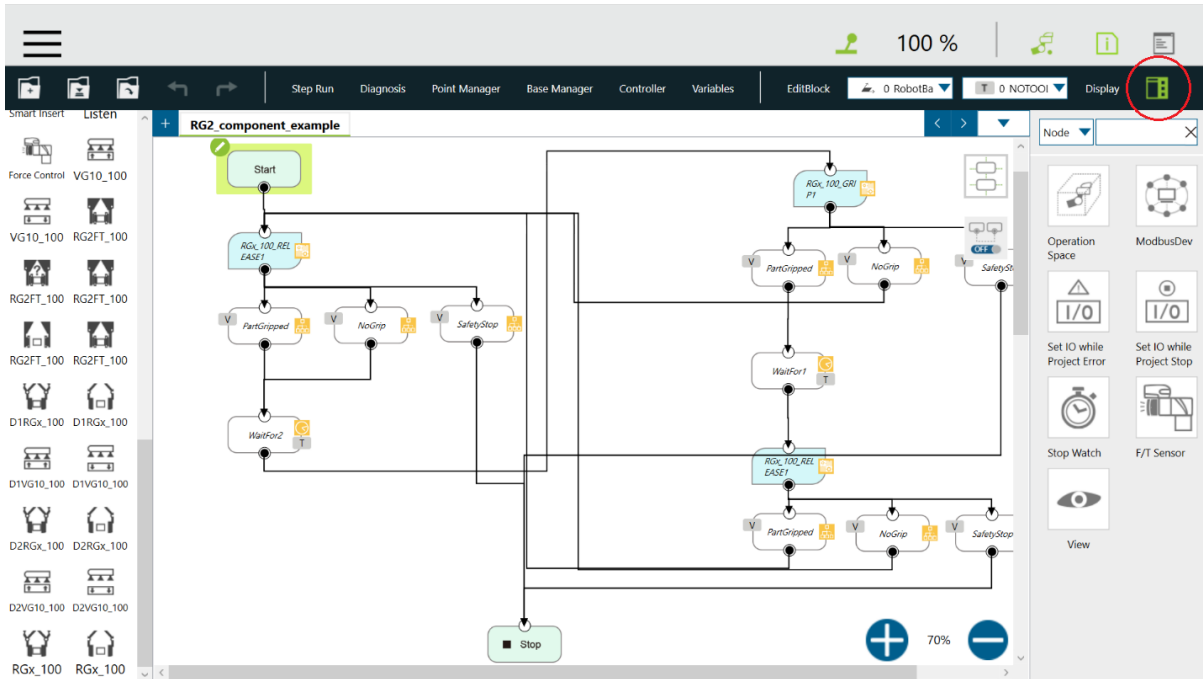

Then click on **ModbusDev**. Select `Gripper_OR_RGx_100_Grip1_mtcp_RG2` and click on the Pencil icon.

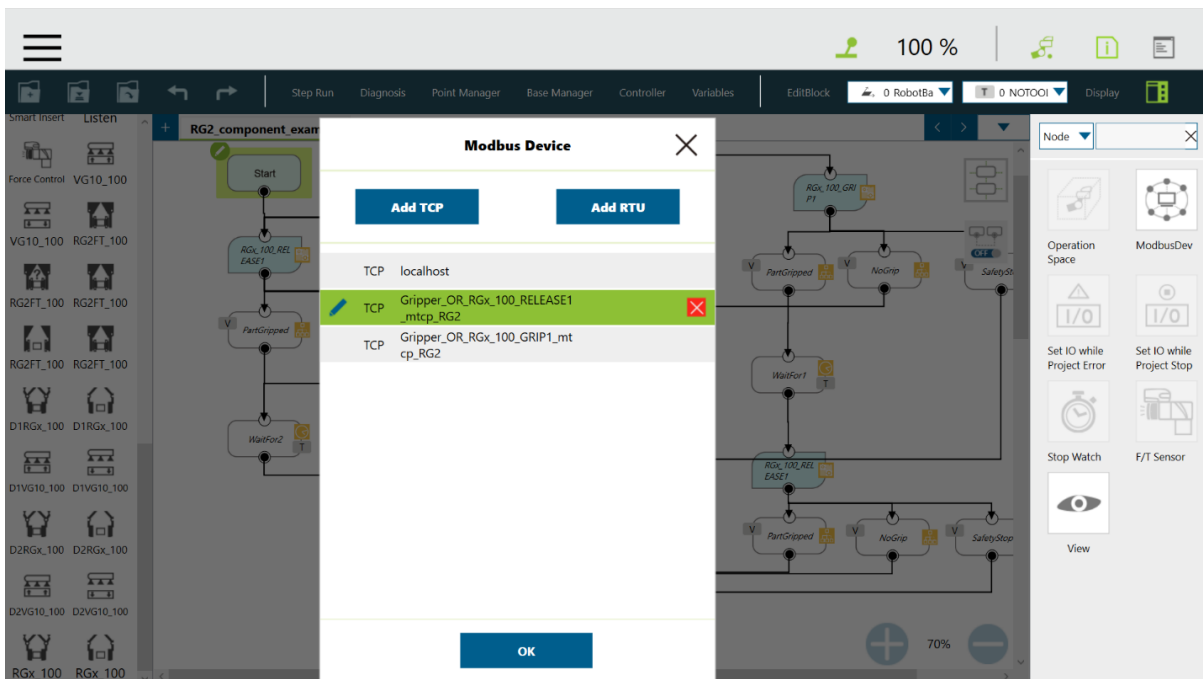

Click on the pencil icon again in the upper right corner.

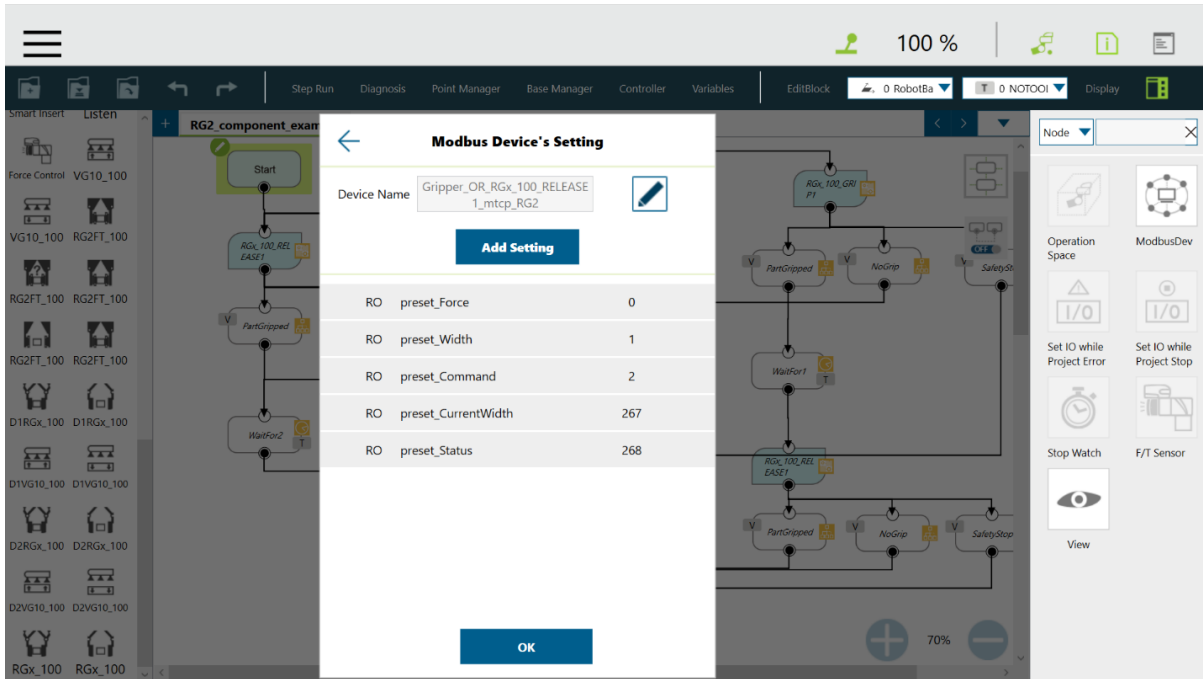

Make sure that the IP address is set correctly.

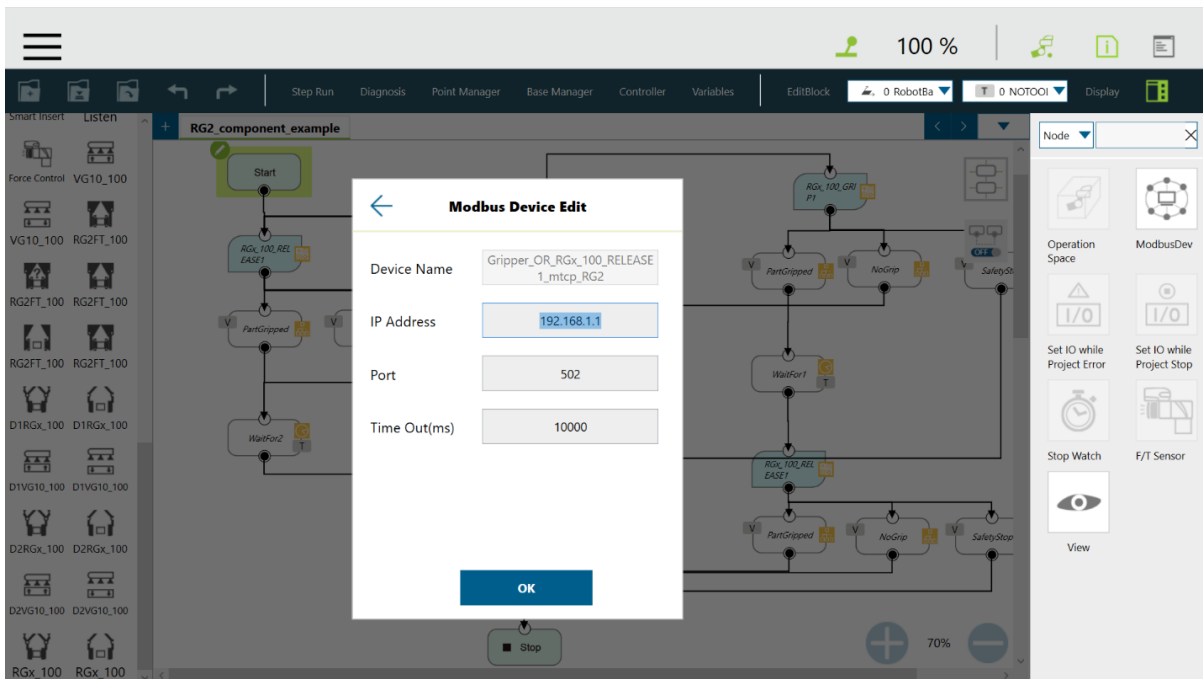

Repeat the same for the other Modbus device if needed.

Software setup is finished.

5. Operation



NOTE:

It is assumed that the Installation has finished successfully. If not, first do the installation steps in the previous section.

5.1. Robot Operation Overview

You can use the previously installed OnRobot components to operate the OnRobot devices from the robot.



NOTE:

OnRobot functions only accept input and returns output in metric units. If you have values to provide in US Standard units, use the following conversion rates.

US Standard unit	Metric unit	Convert US Standard unit into metric parameter input	Convert metric function output to US Standard unit
Linear measure (Length/Distance)			
1 inch (in or ")	25.4 millimetres	Multiply the US Standard input by 25.4 to get the metric unit input.	Divide the metric output by 25.4 to get the US Standard unit output.
1 foot (ft or')	0.304 metre	Multiply the US Standard input by 0.304 to get the metric unit input.	Divide the metric output by 0.304 to get the US Standard unit output.
Mass (Weight)			
1 pound (lb)	0.453 kilogram	Multiply the US Standard input by 0.453 to get the metric unit input.	Divide the metric output by 0.453 to get the US Standard unit output.
Torque			
1 lbft	1.355 Nm	Multiply the US Standard input by 1.355 to get the metric unit input.	Divide the metric output by 1.355 to get the US Standard unit output.

Example

For example, `RGx_100_Grip1` is capable of opening and closing the gripper. The `RGx_100_Release1` is only added so that the Gripper Button can work as well.



NOTE:

The 100 in the component name corresponds to the actual component version (100=1.00).

You can change `Target width` and `Target force` variables by clicking on the arrow icon on the component.

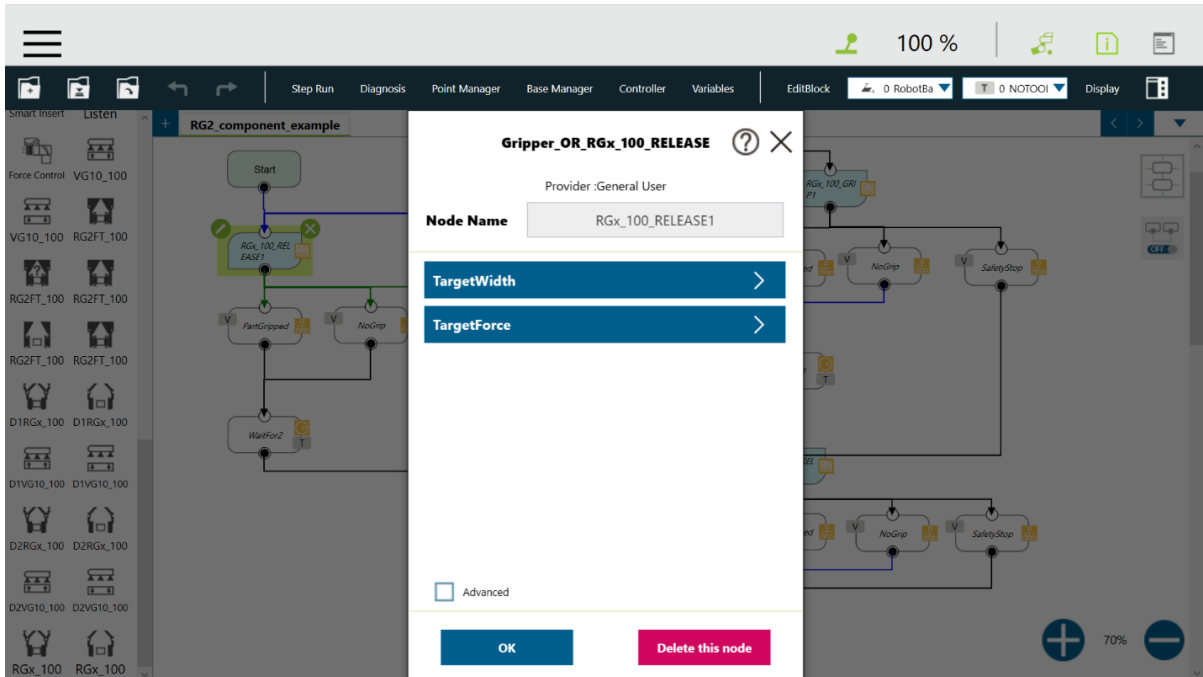

To edit the value, click on the pencil icon.

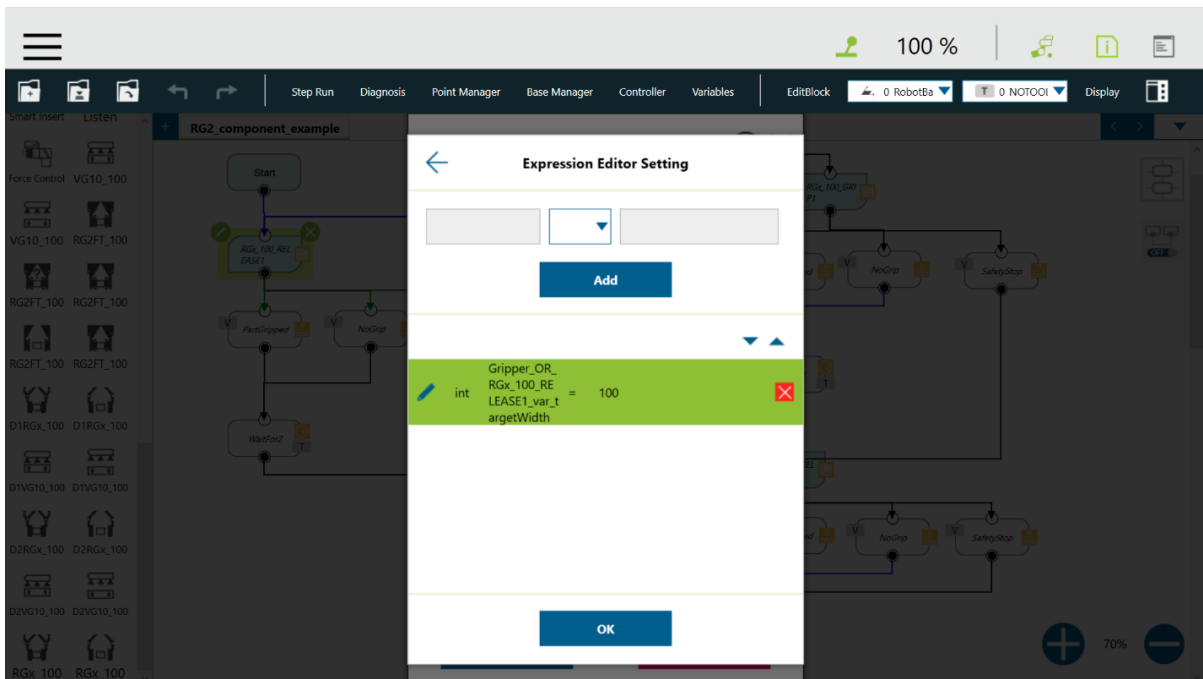

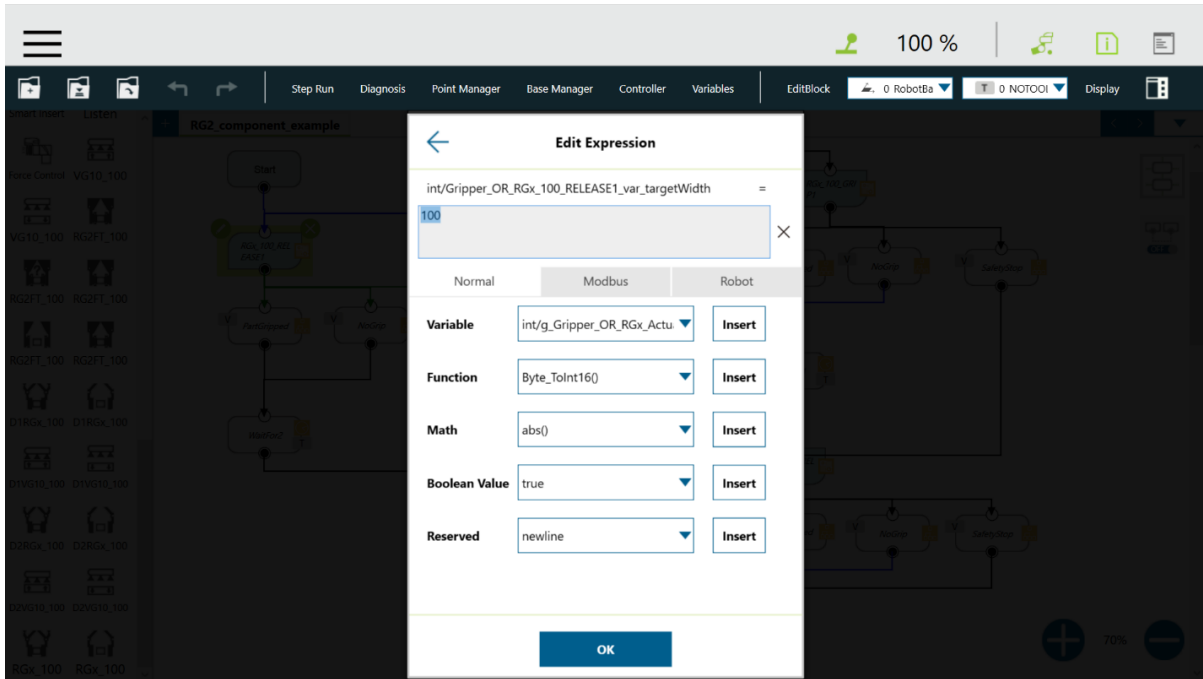

NOTE:

The components with D1 and D2 prefix can be used only with Dual Quick Changer and the given device needs to be connected to 1 - primary or 2 - secondary side.

5.2. Sander Components

5.2.1. SDR_GetParameters

Gets the status parameters of the Sander. The following parameters of the Sander are returned:

- The status of the button (pressed or not)
- The status of the motor (running or not)
- The RPM of the motor
- The temperature of the Sander

These parameters are returned into global variables.

Global variables

Name	Type	Description
g_Tool_OR_SDR_buttonPressed	bool	The state of the button on the Sander
g_Tool_OR_SDR_isRunning	bool	The state of the motor
g_Tool_OR_SDR_RPM	int	The current RPM of the motor

Name	Type	Description
g_Tool_OR_SDR_Temperature	float	The temperature of the Sander

5.2.2. SDR_SetRPM

Commands to start or stop the motor and/or set the Target RPM.

TargetRPM

Sets the target RPM of the Sander. Values under 1000 stop the motor.

Sander	Speed Min [RPM]	Speed Max [RPM]
Start	1000 (Default)	10000
Stop	0	999

Wait

Waits for the motor to ramp up to the desired speed.

Sander	Action
0	Program will continue while motor is ramping up or down
1	Waits until the target RPM is reached (Default)

Timeout

Sets the maximum amount of time to wait until the motor reaches the target RPM. Default is 5000 [ms].

Gateway

- Success: The Sander has successfully started the motor / reached desired RPM.
- MotorStopped: The motor is stopped.
- Timeout: The Sander could not perform the action in the specified time frame.

5.3. Sander Application Guideline

To achieve optimum Sander performance, OnRobot recommends to use a Force/Torque sensor. The Force/Torque sensor is not part of the Sander delivery kit.

To achieve good Sander setup, consider the following parameters and their relations:

Material properties – Push force – Grit size – Tool RPM – Tool speed and Robot parameters

Material Properties

The softer the object is, the more material gets removed with a given grit paper. Consequently, more power is required from the Sander to perform one rotation.

Push Force / Grit Size / Tool RPM

The higher the push force / used grit size / requested RPM, the higher Sander power is needed to perform one rotation.

Tool Speed

The faster the robot goes, the less time the Sander spends on a given area and the less material is removed.

Robot parameters

Compared to manual sanding, the robot is more rigid. When the sanding paper gets in contact with the surface or gets more into the sanding material, the contact causes a higher friction force on the robot joints.

A smaller payload robot can detect this sudden force deviation and can perform a protective stop. Use lower push force, grit size, right Sander RPM, or lower Sander speed to resolve the issue.

Cable routing

The vacuum hose and cable routing can directly affect the force measuring. Make sure that during the sanding process the pulling/pushing force of the cables and the hose is minimized and is the same at every robot position.

6. Additional Software Options

6.1. Compute Box/Eye Box

6.1.1. Ethernet Interface Setup

A proper IP address must be set for the Compute Box/Eye Box and the robot/computer to be able to use the Ethernet interface. The IP address can be configured using DIP switches 3 and 4.



WARNING:

Stop the robot program before you change any Ethernet interface settings.



NOTE:

Configuring DIP switch 3 will remove any previously set static IP address.

To change between modes, first change the DIP switches and then cycle the Compute Box/Eye Box power so the changes will take effect.

DIP 3 - sets the Compute Box / Eye Box IP address

- **ON:** Fixed IP (192.168.1.1)
- **OFF:** Dynamic or Static IP (*can be configured via the Web Client*)

DIP 4 - sets whether the connected robot or laptop will receive IP address from the Compute Box / Eye Box

- **ON:** DHCP server is disabled
- **OFF:** DHCP server is enabled

We recommend to set the DIP switches according to either of the two options below:

- **Fix IP/Auto mode** - in simple installations (no external network and/or no PLC connected)
- **Advanced mode** - in more complex installations (external network and/or PLC are used)

Fix IP/Auto mode (factory default)

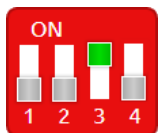

Set the DIP switch 3 to ON and the DIP switch 4 to OFF position and cycle the power so the changes will take effect.

IP Address of the Compute Box/Eye Box	IP Address of the Robot/Computer
<p>The IP address of the Compute Box/Eye Box is fixed 192.168.1.1. This IP address cannot be changed.</p>	<p>The Compute Box/Eye Box will automatically assign an IP address to the connected robot/computer if it was configured to obtain an IP address automatically.</p> <div data-bbox="719 524 817 613" style="display: inline-block; vertical-align: middle;"> </div> <p>NOTE: The assigned IP address range is 192.168.1.100-105 (with subnet mask 255.255.255.0). If the Compute Box/Eye Box is used in a company network where a DHCP server is already in use, it is recommended to use Advanced mode.</p>

In this mode, the DHCP server of the Compute Box/Eye Box is enabled.

Advanced mode (any static or dynamic IP/subnet mask)

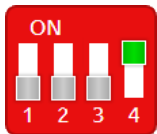

Set the DIP switch 3 to OFF and the DIP switch 4 to ON position and cycle the power so the changes will take effect.

IP Address of the Compute Box/Eye box	IP Address of the Robot/Computer
<p>Case 1: Static IP address The IP address 192.168.1.1 is already in use in your network or a different subnet needs to be configured.</p>	<p>The Compute Box/Eye Box will not assign an IP address to the robot/computer. Set the IP address of the robot/computer manually. Make sure to have a matching IP setting to your robot/computer network for a proper communication. Use the same subnet but different IP address.</p>
<p>Case 2: Dynamic IP address *</p>	<p>The IP address of the robot/computer is set dynamically. An external DHCP server assigns the IP address to the robot/computer.</p>

* By default, the IP address of the Compute Box/Eye Box is set to Dynamic IP.

The IP address of the Compute Box/Eye Box can be set to any value by using the Web Client. For more details, see section Web Client: Configuration Menu. Under **Network settings**, set the **Network mode** to either **Static IP** or **Dynamic IP**.

In this mode, the DHCP server of the Compute Box/Eye Box is disabled.

6.1.2. Web Client

To access the Web Client on your computer first the Ethernet interface needs to be set up to have a proper communication between your computer and the Compute Box. It is recommended to use the factory default DIP switch settings (DIP 3 On and DIP 4 Off) (for further details see section [6.1.1. Ethernet Interface Setup](#)).

Then do the following steps:

- Connect the Compute Box to your computer with the supplied UTP cable.
- Power the Compute Box with the supplied power supply
- Wait one minute for the Compute Box LED to turn from blue to green.
- Open a web browser on your computer and type in the IP address of the Compute Box (factory default is 192.168.1.1).

The Sign-in page opens:

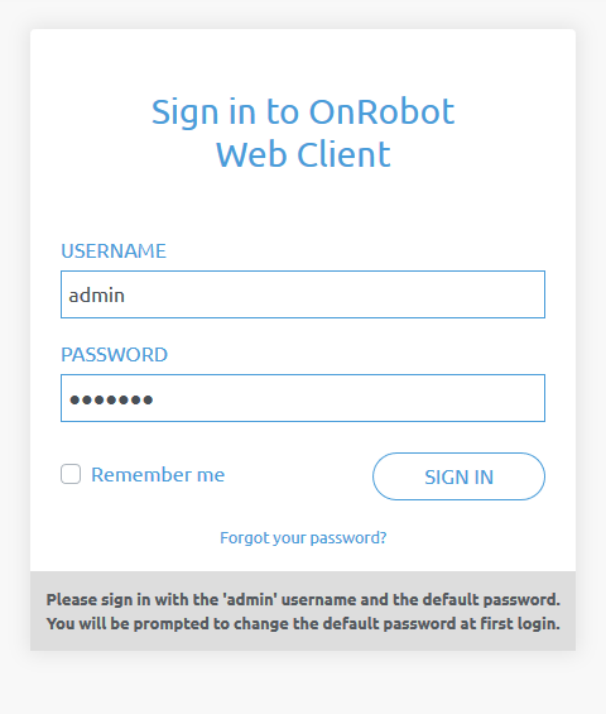

Sign in to OnRobot
Web Client

USERNAME
admin

PASSWORD
●●●●●●

Remember me

[Forgot your password?](#)

Please sign in with the 'admin' username and the default password.
You will be prompted to change the default password at first login.

The factory default administrator login is:

Username: admin

Password: OnRobot

For the first login a new password needs to be entered: (password must be at least 8 characters long)

Change the default administrator password

NEW PASSWORD

CONFIRM PASSWORD

SUBMIT

Once signed in the following top menu appear:





- **Devices** - Monitor and control the connected devices (e.g.: grippers)
- **Configuration** - Change the Compute Box's settings
- **WebLogic™** - Program the Digital I/O interface through OnRobot WebLogic™
- **Paths** - Import/export the recorded Paths (not available to all robots)
- **Update** - Update the Compute Box and the devices
- Account settings (e.g.: change password, add new user)
- Select the language of the Web Client

In the following, these menus will be described.

6.1.3. Web Client: Devices Menu

To control/monitor a device click on the **Select** button.

Please select from the detected device(s):

 <p>Compute Box</p> <p>SELECT</p>	 <p>HEX-E/H QC</p> <p>SELECT</p>	 <p>RG2</p> <p>SELECT</p>
---	--	---

6.1.3.1. Sander

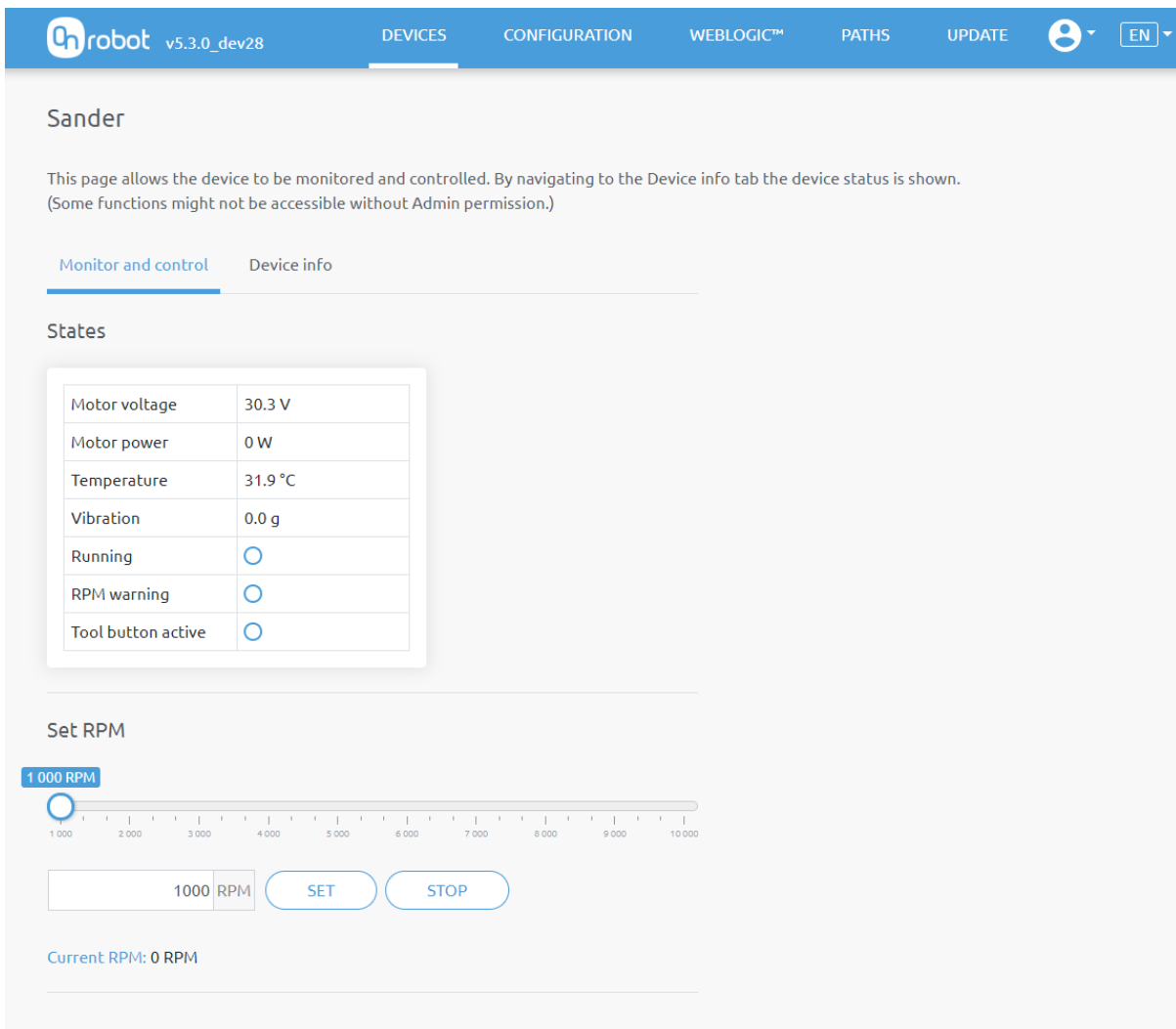

States

Motor voltage - Displays the voltage usage of the Sander in V.

Motor power - Displays the power consumption of the Sander in W.

Temperature - Displays the temperature of the Sander in °C.

Vibration - Displays the vibration of the Sander.

Running - Display the state of the Sander if the motor is running.

RPM warning - Display if the **RPM deviation** parameter is reached or exceeded.

Tool button active - Displays the state of the Sander button.

Set RPM

Use the **Set RPM** slider to control the RPM value.

Set - Sets a new RPM value.

Stop - Stops the motor.

Current RPM - Displays the current RPM value.

6.1.4. Web Client: Configuration Menu

Configuration

This page allows the configuration of the Compute Box.

CAUTION
 Incorrect settings may cause the device to lose network connectivity.

1. Digital input mode: NPN
2. Digital output mode: NPN
3. Compute Box IP setting is configured on this page.
4. DHCP server enabled: Compute Box tries to assign IP to the robot.

NETWORK SETTINGS

MAC address	b8:27:eb:0e:c9:a3
Network mode	Static IP ⌵
IP address	192.168.1.1 ✎
Subnet mask	255.255.255.0 ✎

SAVE

ETHERNET/IP SCANNER SETTINGS

IP address to connect to	_____
Origin-to-target instance id	1
Target-to-origin instance id	1
Configuration instance id	0
Requested packet interval (ms)	8

SAVE

COMPUTE BOX SETTINGS

Display name

✎

SAVE

Clock delay
5 min
⚠

SYNCHRONIZE CLOCK

Network settings:

The **MAC address** is a world-wide unique identifier that is fixed for the device.

The **Network mode** drop-down menu can be used to decide if the Compute Box will have a static or a dynamic IP address:

- If it is set to **Dynamic IP**, the Compute Box expects an IP address from a DHCP server. If the network that the device is connected to has no DHCP server, the Compute Box will not obtain an IP address and its LED is lighting in blue.
- If it is set to **Static IP**, then a fixed IP address and subnet mask must be set.
- If it is set to **Default Static IP**, the fixed IP revert to the factory default and cannot be changed.

After all parameters are set, click on the **Save** button to store the new values permanently. Wait 1 minute and reconnect to the device using the new settings.

Compute Box / Eye Box settings:

In case, more than one Compute Box is used within the same network, for identification purpose any user specific name can be entered to the **Display name**.

If the **Clock delay** field shows a difference, click **Synchronize clock** to synchronize the Compute Box's time with your computer.

EtherNet/IP scanner settings:



NOTE:

This is a special option of the EtherNet/IP connection for some robots.

In case when the robot is the Adapter and the Compute Box needs to be the Scanner the following addition information is required for the communication:

- **IP address to connect to** - the robot IP address
- **Origin-to-target instance id** - refer to the robot's EtherNet/IP manual (Scanner mode)
- **Target-to-origin instance id** - refer to the robot's EtherNet/IP manual (Scanner mode)
- **Configuration instance id** - refer to the robot's EtherNet/IP manual (Scanner mode)
- **Requested packet interval (ms)** - RPI value in ms (minimum 4)

Check the checkbox and the Compute Box will try to automatically connect to the robot (via the given IP address).

6.1.5. Web Client: Update Menu

This page can be used to update the software on the Compute Box and the firmware on the devices.

Update

This page allows updating the software and firmware.

CAUTION
Installing updates may take several minutes to complete. Please do not power off or unplug your Compute Box or any of the connected devices during the update process.

SOFTWARE

No update file selected yet...

BROWSE

[Click here to download the result of the last update.](#)

FIRMWARE

COMPONENTS	CURRENT VERSION	REQUIRED VERSION	
Compute Box (CBOX_RPT)			
Firmware	150	150	✓
HEX-E/H QC (HEXHC001)			
Firmware	208	208	✓

UPDATE

✓ Up-to-date
 ↻ Update required
 ✗ Downgrade not supported



CAUTION:

During the update process (takes about 5-10 minutes) DO NOT unplug any device or close the browser window. Otherwise the updated device could be damaged.

The loading screens during the update process are the same for the software and the firmware updates.

Software Update

Start the software update by clicking on the **Browse** button to browse for the .cbu software update file.

Then the **Browse** button will turn to **Update**.

Click on that **Update** button to start the software update process, see below.

If the update is finished and was successful, the message below is shown.

Firmware Update

The firmware update is only required when any of the components is out of date.

To start the firmware update, click on **Update** button in the firmware section of the page, see below.

If the update is finished and was successful, the message below is shown.

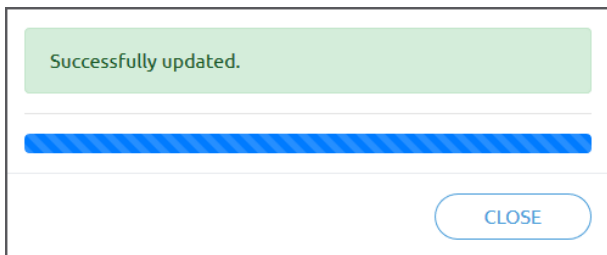
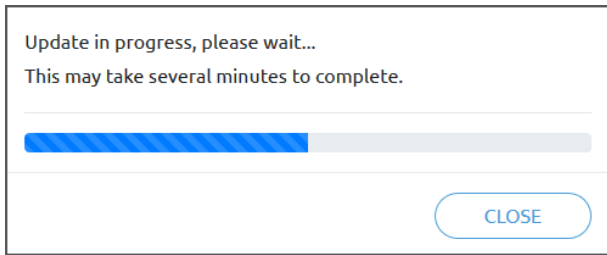

6.1.6. Web Client: Account Settings

This menu can be used to:

- See the currently sign-id user
- Go to **Account settings**
- Sign-out

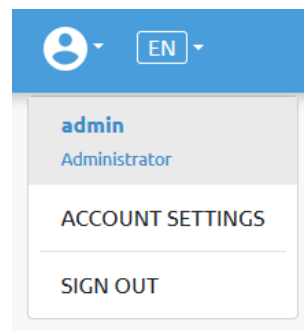

Account settings:

This page has two tabs:

- **My profile** - to see and update the currently logged in users' profile (e.g.: change password)
- **Users** - to manage users (e.g.: add/remove/edit)

On the **My profile** tab to change any profile data (e.g.: password) click on the **Update profile** button.

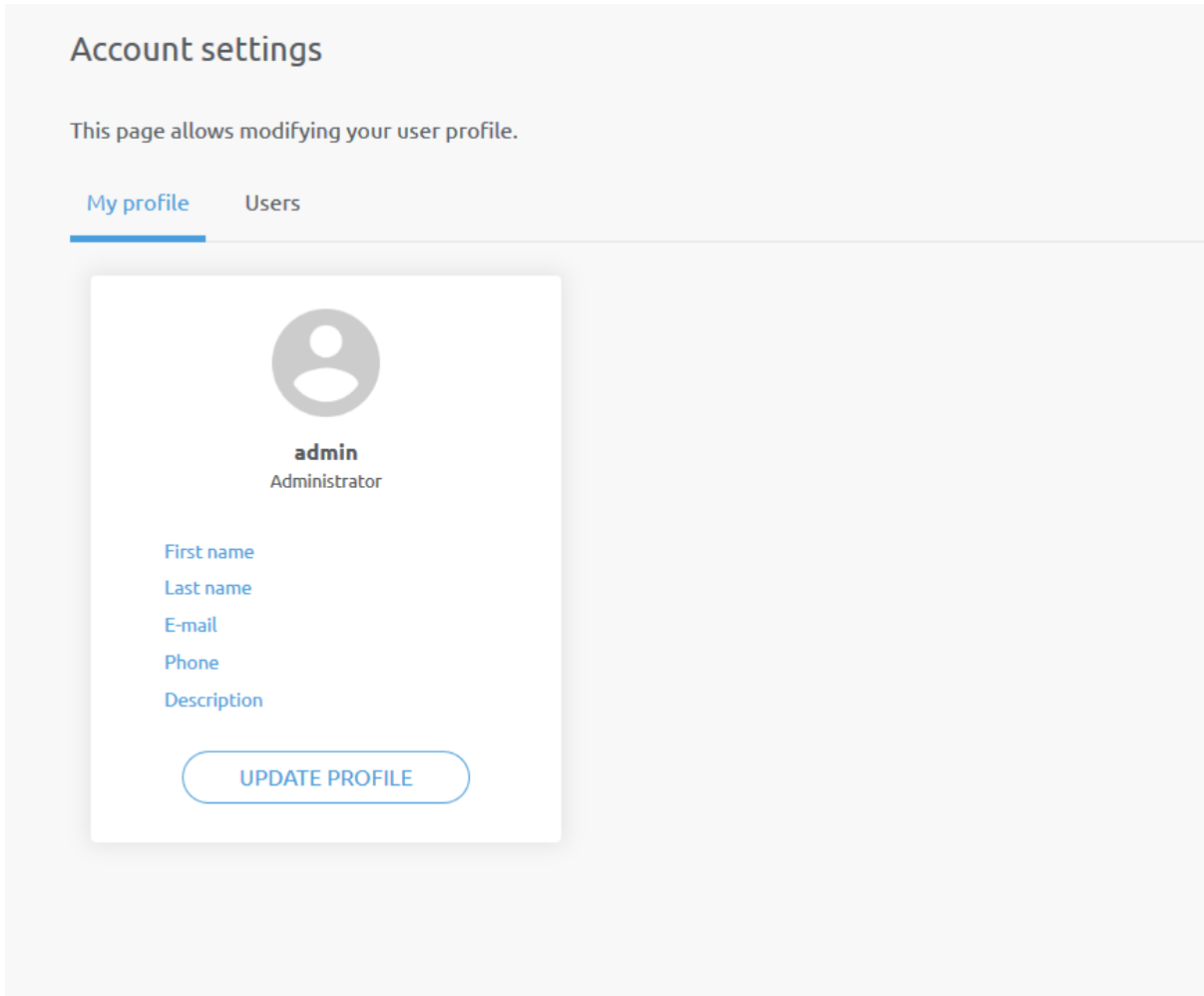

On the **Users** tab click on the **Add new user** button to add more users:

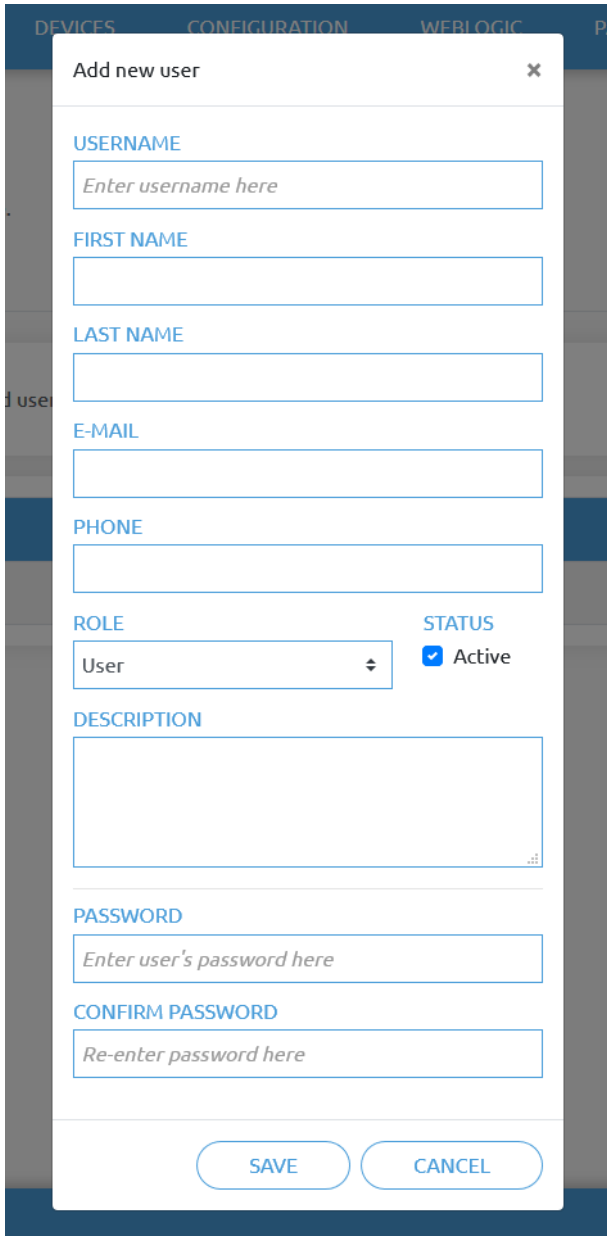

The screenshot shows a modal window titled "Add new user" with a close button (X) in the top right corner. The form contains the following fields and controls:

- USERNAME:** A text input field with the placeholder text "Enter username here".
- FIRST NAME:** A text input field.
- LAST NAME:** A text input field.
- E-MAIL:** A text input field.
- PHONE:** A text input field.
- ROLE:** A dropdown menu currently showing "User".
- STATUS:** A checkbox labeled "Active" which is checked.
- DESCRIPTION:** A text area with a small grid icon in the bottom right corner.
- PASSWORD:** A text input field with the placeholder text "Enter user's password here".
- CONFIRM PASSWORD:** A text input field with the placeholder text "Re-enter password here".

At the bottom of the form are two buttons: "SAVE" and "CANCEL".

There are three user levels:

- Administrator
- Operator
- User

Fill in the user information and click **Save**.



Later on to change any user information just click on the edit  icon.

Account settings

This page allows modifying your user profile.

My profile **Users**

[ADD NEW USER](#) You can add user on your network to monitor and control the devices.

USERNAME	ROLE	FIRST NAME	LAST NAME	E-MAIL	PHONE	ACTIVE	
admin	Administrator					<input checked="" type="checkbox"/>	
operator	User					<input checked="" type="checkbox"/>	 

To prevent a user to sign-in either could be:

- deactivated by changing its **Active** status in the edit mode
- or removed by clicking the delete  icon.

7. Hardware Specification

7.1. Technical Sheets

7.1.1. Sander

General Properties	Minimum	Typical	Maximum	Unit
Pad diameter	-	-	127 [5]	mm [inch]
Pad height	-	-	9.5 [0.37]	mm [inch]
Orbit size	-	-	5 [3/16]	mm [inch]
Rotation speed - RPM	1,000	-	10,000	RPM
Pad type (3M: 20353)	Clean Sanding Disc Pad			
Pad media type ⁽¹⁾	Hookit™			
Pad weight ⁽¹⁾	0.1 [0.22]			kg [lb]
Weight (with pad) ⁽¹⁾	1.2 [2.645]			kg [lb]
IP rating	IP54			
Dimensions (outer)	87 x 123 x 214 [3.42 x 4.84 x 8.42]			mm [inch]

(1)

**WARNING:**

Using different pad weight may cause increased vibration. Increase the speed gradually upon pad replacement to ensure correct balancing.

Operating Conditions	Minimum	Typical	Maximum	Unit
Sanding power	-	150	-	W
Operation voltage	External voltage	-	30	V
	External power	-	150	W
	Tool connector voltage	-	24	V
	Tool connector power	-	2.4	W
Operation temperature	0 [32]	-	50 [122]	°C [°F]
Noise level at 10,000 RPM (3,000 RPM)	-	74 (44)	-	[dB]

7.1.2. Compute Box

7.1.2.1. With 1.5A Wall Adapter (36W)

Supplied Wall Adapter	Minimum	Typical	Maximum	Unit
Input voltage (AC)	100	-	240	[V]
Input current	-	-	1	[A]
Output voltage	-	24	-	[V]
Output current	-	1.5	-	[A]

Compute Box Power input (24V connector)	Minimum	Typical	Maximum	Unit
Supply voltage	-	24	25	[V]
Supply current	-	1.5	-	[A]

Compute Box Power output (Device connector)	Minimum	Typical	Maximum	Unit
Output voltage	-	24	25	[V]
Output current	-	1.5	-	[A]

7.1.2.2. With 6.25A Wall Adapter (150W)

Supplied Wall Adapter	Minimum	Typical	Maximum	Unit
Input voltage (AC)	100	-	240	[V]
Input current	-	-	2.1	[A]
Output voltage	-	24	-	[V]
Output current	-	6.25	-	[A]

Compute Box Power input (24V connector)	Minimum	Typical	Maximum	Unit
Supply voltage	-	24	25	[V]
Supply current	-	6.25	-	[A]

Compute Box Power output (Device connector)	Minimum	Typical	Maximum	Unit
Output voltage	-	24	25	[V]
Output current	-	4.5	4.5*	[A]

* Peak currents

7.1.2.3. Compute Box I/O interface

Power Reference (24V, GND)	Minimum	Typical	Maximum	Unit
Reference output voltage	-	24	25	[V]
Reference output current	-	-	100	[mA]

Output (DO1-DO8)	Minimum	Typical	Maximum	Unit
Output current - altogether	-	-	100	[mA]
Output resistance (active state)	-	24	-	[Ω]

Input (DI1-DI8) as PNP	Minimum	Typical	Maximum	Unit
Voltage level - TRUE	18	24	30	[V]
Voltage level - FALSE	-0.5	0	2.5	[V]
Input current	-	-	6	[mA]
Input resistance	-	5	-	[k Ω]

Input (DI1-DI8) as NPN	Minimum	Typical	Maximum	Unit
Voltage level - TRUE	-0.5	0	5	[V]
Voltage level - FALSE	18	24	30	[V]
Input current	-	-	6	[mA]
Input resistance	-	5	-	[k Ω]

7.2. Mechanical Drawings

7.2.1. Mountings

7.2.1.1. Quick Changer - Robot Side

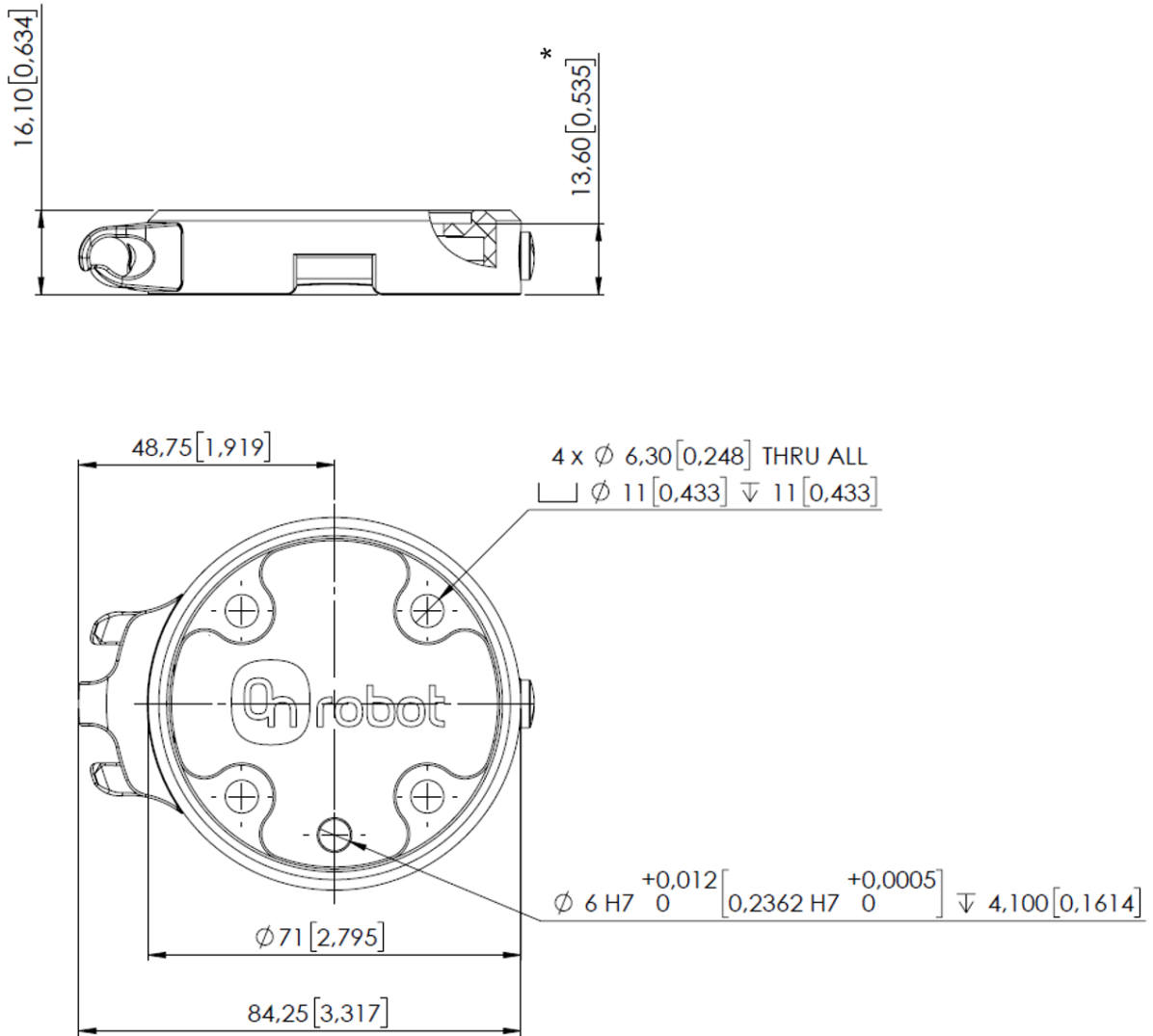

* Distance from Robot flange interface to OnRobot tool.

All dimensions are in mm and [inches].



NOTE:

The cable holder (on the left side) is only required with the long (5 meter) cable.

7.2.2. Tools

7.2.2.1. Sander

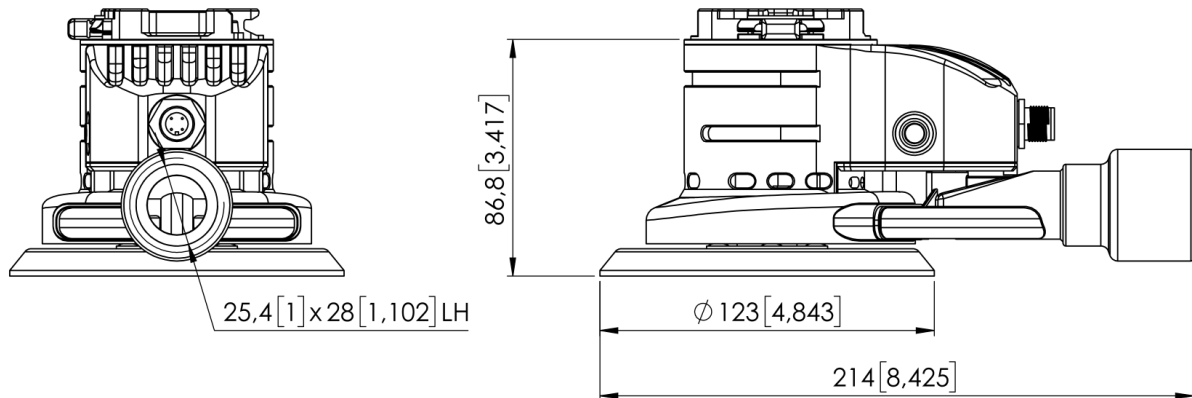

All dimensions are in mm and [inches].

7.2.2.2. Power Supply of the Sander

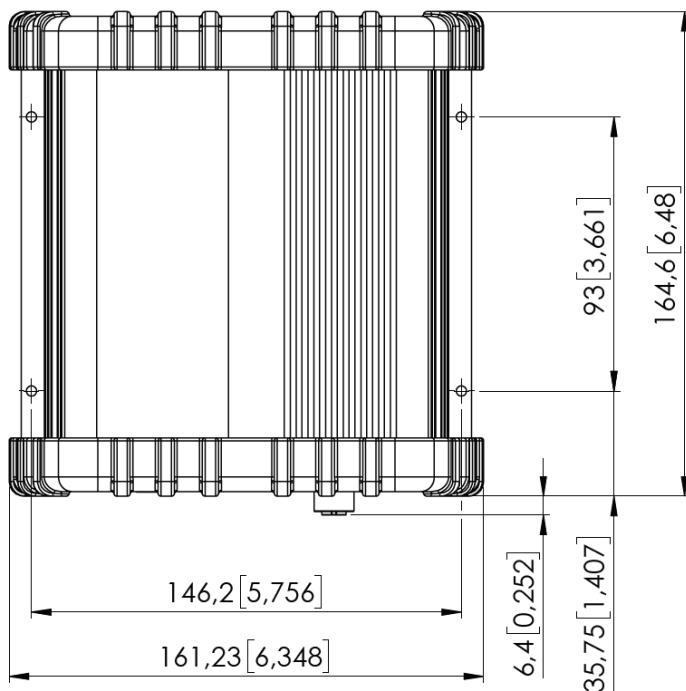
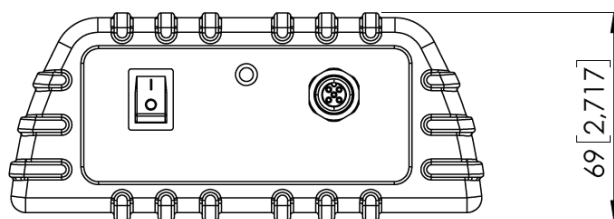

All dimensions are in mm and [inches].

7.2.2.3. Compute Box

Compute Box

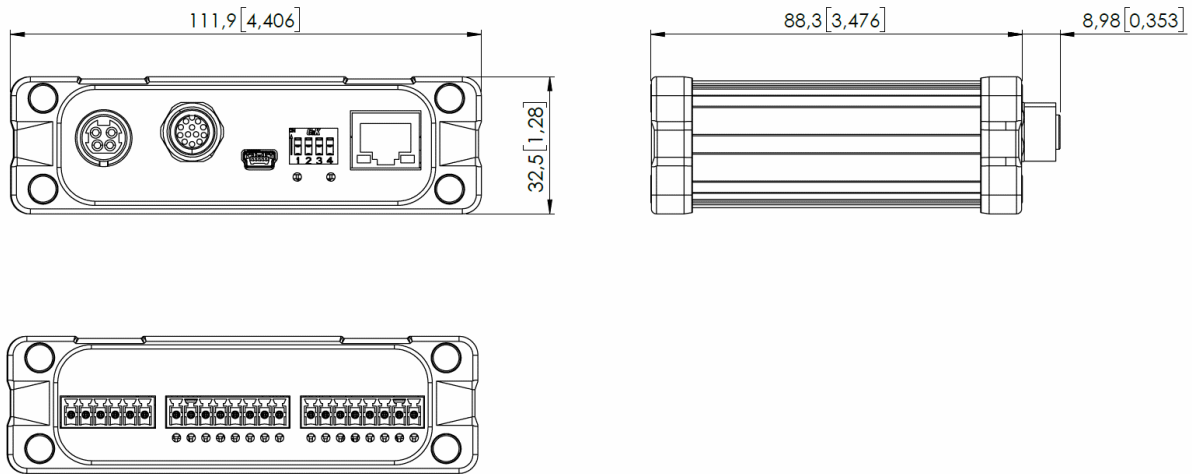

Clip-on Bracket (optional)

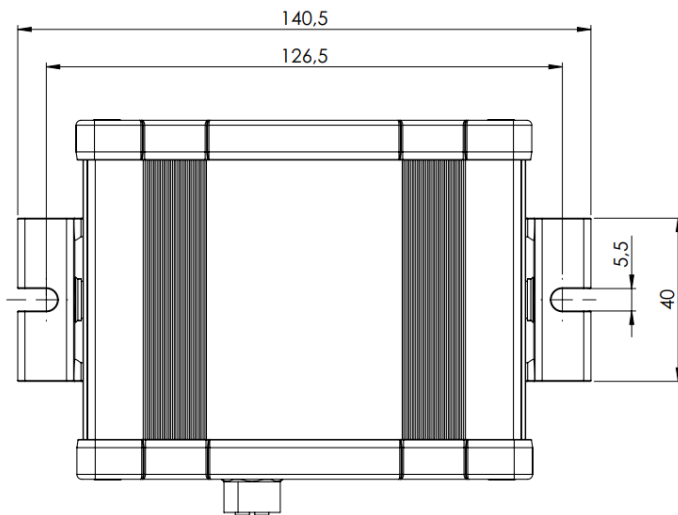

All dimensions are in mm and [inches].

7.3. COG, TCP

COG, TCP, and weight parameters of the single devices (without any mounting/adapter):

7.3.1. Sander

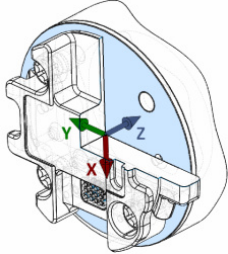
Coordinate System	TCP [mm]	Center of Gravity [mm]	Weight
	<p>X = 0 Y = 0 Z = 87.1</p>	<p>cX = 13.79 cY = 0.24 cZ = 35.39</p>	<p>1.179 kg 2.5992 lb</p>

Use the TCP/COG Calculator to calculate the TCP and COG values for your OnRobot product combination.

The TCP/COG Calculator can be downloaded from www.onrobot.com/downloads.

8. Maintenance



WARNING:

An overall inspection of the OnRobot's End of Arm Tooling must be performed regularly and at least once every 6 months. This inspection must include but is not limited to check for defective material and clean gripping surfaces.

Use original spare parts, and original service instructions for the OnRobot's End of Arm Tooling and the robot. Failure to comply with this precaution can cause unexpected risks, resulting in severe injury.

If you have questions regarding spare parts and repair, please visit our website www.onrobot.com to contact us.

9. Troubleshooting

9.1. Robot Has Not Obtained an IP Address

If the Compute Box has not assigned an IP address to the robot, do the following:

Assign a static IP address to the robot that matches your current IP settings on your Compute Box. The default IP address of the Compute Box is 192.168.1.1.



NOTE:

Change the last number in the IP address (if using 255.255.255.0 subnet mask) to avoid an IP conflict with the Compute Box.

Example

If the default fixed (192.168.1.1) IP address is used on the Compute Box, then use the following values:

- IP address: 192.168.1.2
- Subnet Mask: 255.255.255.0

9.2. Error During Operation

If an error occurs during operation, try the following:

1. Restart the robot and check the functionality.
2. If the error is still present, contact the distributor from where the product has been purchased.

10. Warranties

10.1. Patents

Products of OnRobot A/S are protected by several patents; some still in global publication process (Patents pending). All manufacturers of copies and similar products violating any patent claims will be prosecuted.

10.2. Product Warranty

Without prejudice to any claim the user (customer) may have in relation to the dealer or retailer, the customer shall be granted a manufacturer's warranty under the conditions set out below:

In the case of new devices and their components exhibiting defects resulting from manufacturing and/or material faults within 12 months of entry into service (maximum of 15 months from shipment), OnRobot A/S shall provide the necessary spare parts, while the customer (user) shall provide working hours to replace the spare parts, either replace the part with another part reflecting the current state of the art, or repair the said part. This warranty shall be invalid if the device defect is attributable to improper treatment and/or failure to comply with information contained in the user guides. This warranty shall not apply to or extend to services performed by the authorized dealer or the customer themselves (e.g. installation, configuration, software downloads). The purchase receipt, together with the date of purchase, shall be required as evidence for invoking the warranty. Claims under the warranty must be submitted within two months of the warranty default becoming evident. Ownership of devices or components replaced by and returned to OnRobot A/S shall vest in OnRobot A/S. Any other claims resulting out of or in connection with the device shall be excluded from this warranty. Nothing in this warranty shall attempt to limit or exclude a customer's statutory rights nor the manufacturer's liability for death or personal injury resulting from its negligence. The duration of the warranty shall not be extended by services rendered under the terms of the warranty. Insofar as no warranty default exists, OnRobot A/S reserves the right to charge the customer for replacement or repair. The above provisions do not imply a change in the burden of proof to the detriment of the customer. In case of a device exhibiting defects, OnRobot A/S shall not be liable for any indirect, incidental, special or consequential damages, including but not limited to, lost profits, loss of use, loss of production or damage to other production equipment.

In case of a device exhibiting defects, OnRobot A/S shall not cover any consequential damage or loss, such as loss of production or damage to other production equipment.

10.3. Disclaimer

OnRobot A/S continues to improve reliability and performance of its products, and therefore reserves the right to upgrade the product without prior warning. OnRobot A/S ensures that the content of this manual is precise and correct but takes no responsibility for any errors or missing information.

11. Certifications



This is to certify that the management system of:

OnRobot A/S

Main Site: Teglværksvej 47 H, 5220 Odense SØ, Denmark
 Chamber of Commerce: 36492449
 Additional Site: OnRobot A/S, Cikorievej 44, 5220 Odense SØ, Denmark

has been registered by Intertek as conforming to the requirements of

ISO 9001:2015

The management system is applicable to:

Development and sales of End-of-Arms tools for industrial customers worldwide.

Certificate Number:
0096721

Initial Certification Date:
26 November 2019

Date of Certification Decision:
26 November 2019

Issuing Date:
26 November 2019

Valid Until:
25 November 2022



Intertek

Carl-Johan von Plomgren
MD, Business Assurance Nordics

Intertek Certification AB
 P.O. Box 1103, SE-164 22 Kista, Sweden



In the issuance of this certificate, Intertek assumes no liability to any party other than to the Client, and then only in accordance with the agreed upon Certification Agreement. This certificate's validity is subject to the organization maintaining their system in accordance with Intertek's requirements for systems certification. Validity may be confirmed via email at certificate.validation@intertek.com or by scanning the code to the right with a smartphone. The certificate remains the property of Intertek, to whom it must be returned upon request.



11.1. EMC



Attestation of Conformity no. 120-33441-A1

FORCE Technology has performed compliance testing on electrical products since 1967. FORCE Technology is an accredited test house according to EN17025 and participates in international standardization with organizations such as CEN/CENELEC, IEC/CISPR and ETSI. This attestation of conformity with the below mentioned standards and/or normative documents is based on accredited tests and/or technical assessments carried out at FORCE Technology.

Attestation holder OnRobot A/S Teglværksvej 47H 5220 Odense SØ Denmark	
Product identification - Name (Part no.) Power Supplies: PSU (104788), VER36U240-JA, VES120PS24, VES150PS24. Controllers: UR Kit with Compute Box (102344), Doosan Robot kit (102345), Techman/OMRON TM Robot Kit (102359), KUKA-A Robot kit (102360), KUKA-B Robot kit (102361), FANUC Robot kit (102362), Kawasaki-B Robot kit (102363), Kawasaki-C Robot kit (102364), Kawasaki-D Robot kit (102365), Kawasaki-E Robot kit (102366), Yaskawa-F Robot kit (102367), Yaskawa-G Robot kit (102368), Yaskawa-H Robot kit (102369), NACHI-I Robot kit (102370), NACHI-J Robot kit (102371), Hanwha Robot Kit (103208), Eye Box (103707). Mountings: Dual Quick Changer (101788), Quick Changer Robot side (102037), HEX-E QC (102111), Quick Changer Kit (102277), HEX-H QC (102376), Quick Changer Robot side 4,5A (104277), Dual Quick Changer 4,5A (104293), Quick Changer Kit 4,5A (104388). Tools: 2FG7 (106376), 3FG15 (103666), MG10 (105202), OnRobot Eyes (103903), RG2 (102012), RG2-FT (102075), RG6 (102021), Sander (106376), Screwdriver (103961), SG Base Part (103546), VG10 (101661), VGC10 (102844), VGP20 (107242).	
Manufacturer OnRobot A/S	
Technical documentation Assessment no. 120-33441-A1	
Standards/Normative documents IEC 61000-3-2:2018 IEC 61000-3-3:2013/AMD1:2017 IEC 61000-6-2:2016 IEC 61000-6-4:2018 EMC Directive 2014/30/EU, Article 6 EN 61000-3-2:2014 EN IEC 61000-3-2:2019 EN 61000-3-3:2013/A1:2019 EN 61000-6-2:2005/AC:2005 EN IEC 61000-6-2:2019 EN 61000-6-4:2007/A1:2011 EN IEC 61000-6-4:2019 Additionally, for RG2 (102012) and RG6 (102021): IEC 61326-3-1:2017, Industry locations, SIL 2 The product identified above has been assessed and complies with the specified standards/normative documents. The attestation does not include any market surveillance. It is the responsibility of the manufacturer that mass-produced apparatus have the same properties and quality. This attestation does not contain any statements pertaining to the requirements pursuant to other standards, directives or laws other than the above mentioned.	
Signature 	Digitally signed by Knud A. Baltsen Date: 2021.03.02 16:14:10 +01'00'
Signed by: Knud A. Baltsen, Senior Specialist, Product Compliance	



FORCE Technology
 Venlighedsvej 4
 2970 Hørsholm, Denmark
 +45 43 25 14 00
 +45 43 25 00 10
 info@forcetechnology.dk

FORCE Technology Norway AS
 Nye Vakkås vei 32
 1395 Hvalstad, Norway
 +47 64 00 35 00
 +47 64 00 35 01
 info@forcetechnology.no

FORCE Technology
 Park Allé 345
 2605 Brøndby, Denmark
 +45 43 25 00 00
 +45 43 25 00 10
 info@forcetechnology.dk

11.2. Declaration of Incorporation

11.2.1. Sander

CE/EU Declaration of Incorporation (Original)

According to European Machinery Directive 2006/42/EC annex II 1.B.

The manufacturer:

OnRobot A/S
 Teglværskvej 47H
 DK-5220, Odense SØ
 DENMARK

declares that the product:

Type:	Industrial Robot Sander
Model:	OnRobot Sander
Generation:	V1
Serial:	1000000000-1009999999

may not be put into service before the machinery in which it will be incorporated is declared in conformity with the provisions of Directive 2006/42/EC, including amendments, and with the regulations transposing it into national law.

The product is prepared for compliance with all essential requirements of Directive 2006/42/EC under the correct incorporation conditions, see instructions and guidance in this manual. The following essential requirements of Directive 2006/42/EC are fulfilled: 1.1.2, 1.1.3, 1.1.5, 1.3.2, 1.3.4, 1.5.1, 1.5.2, 1.5.4, 1.5.5, 1.5.10, 1.5.11, 1.5.12, 1.6.1. Compliance with all essential requirements of Directive 2006/42/EC relies on the specific robot installation and the final risk assessment.

Technical documentation is compiled according to Directive 2006/42/EC annex VII part B and available in electronic form to national authorities upon legitimate request. Undersigned is based on the manufacturer address and authorized to compile this documentation.

Additionally, the product declares in conformity with the following directives, according to which the product is CE marked:

2014/30/EU — Electromagnetic Compatibility Directive (EMC)
 2011/65/EU — Restriction of the use of certain hazardous substances (RoHS)

Relevant essential health and safety requirements of the following EU directives are also applied:

2014/35/EU — Low Voltage Directive (LVD)
 2012/19/EU — Waste of Electrical and Electronic Equipment (WEEE)

A list of applied harmonized standards, including associated specifications, is provided in this manual.

Budapest, November 11th, 2020

Group Management

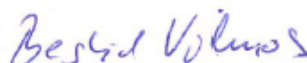
 Vilmos Beskid
 CTO